

Specifications

Rating:	25mA 24VDC (switching), 100mA 50VDC (steady state)
Contact Resistance:	100mΩ Max
Insulation Resistance:	100MΩ Min
Dielectric Strength:	300VAC
Operating Temperature:	-40°C to +85°C
Electrical Life:	1000+ Cycles
Operating Force:	9.8N Max

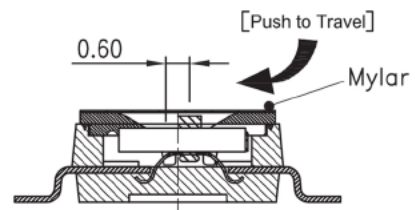

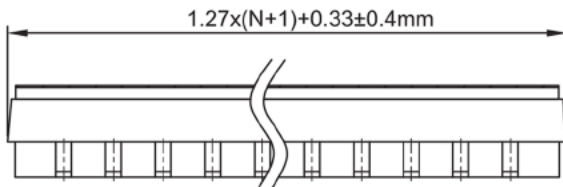
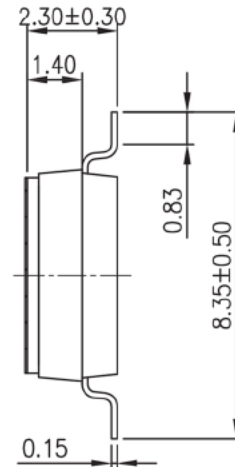
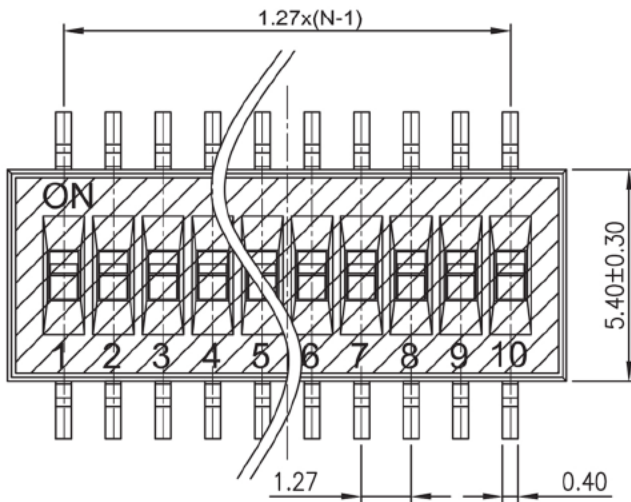
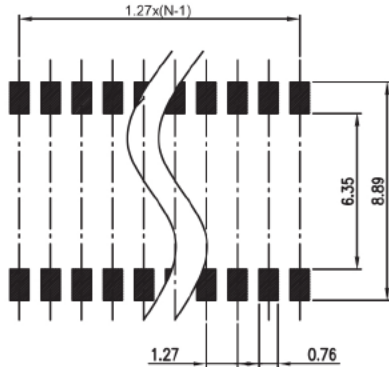

RECOMMENDED P.C.B. LAYOUT (TOP VIEW)

[Schematic]

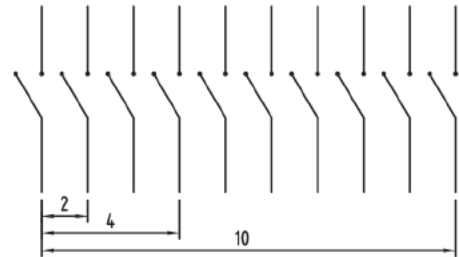

(Construction)

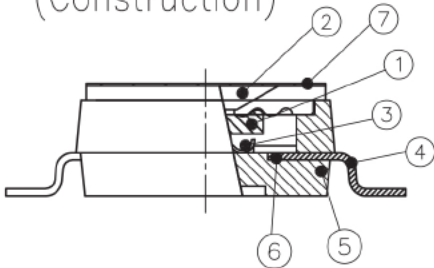

Number	Part Name	Material	Finished
①	Actuator	UL94 V0	White
②	Cover	UL94 V0	Black
③	Movable	Beryllium Copper	3μ' Gold
④	Terminal	Brass	1μ' Gold
⑤	Base	UL94 V0	Black
⑥	Terminal Contact	Brass	3μ' Gold
⑦	Mylar	UL94 V0	0.05mm

Description	Ref Code
2 Way Half Pitch SMD DIL Switch 1.27mm	483046