

Specifications

Rating:	50mA 12VDC
Contact Resistance:	50mΩ Max
Insulation Resistance:	100MΩ Min
Dielectric Strength:	250VAC 1 minute
Operating Force:	180gf
Electrical Life:	100,000+ Cycles
Operating Temperature:	-30°C to +70°C

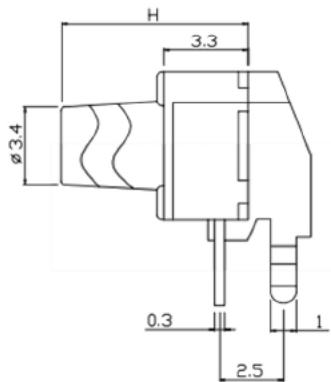

H
4.3
5.0
6.0
7.0
8.0
13.0

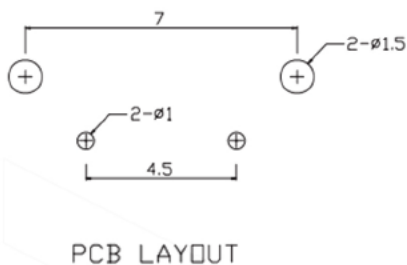
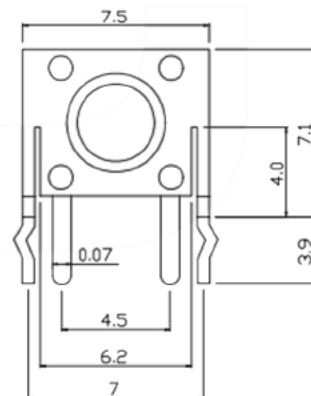

Description	Ref Code
6x6mm Right Angle Momentary PCB Tactile Switch 5.0mm	122036