

Specifications

Rating:	50mA 12VDC
Contact Resistance:	50mΩ Max
Insulation Resistance:	100MΩ Min
Dielectric Strength:	250VAC 1 minute
Operating Force:	180gf
Electrical Life:	100,000+ Cycles
Operating Temperature:	-30°C to +70°C

Dimension (unit: mm)

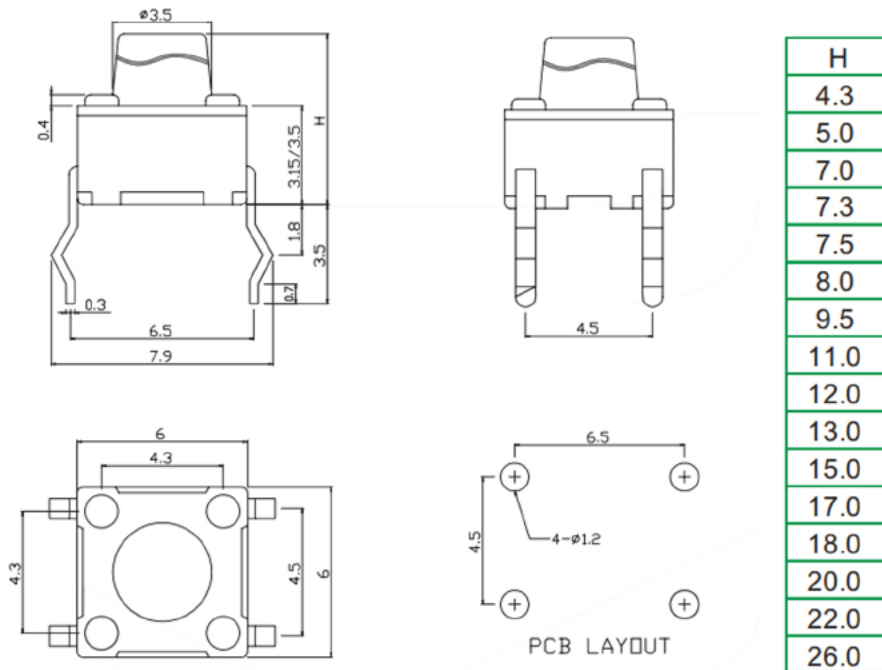

Description	Ref Code
6x6x7mm Momentary PCB Tactile Switch	122013