

Specifications

Rating:	50mA 12VDC
Contact Resistance:	50mΩ Max
Insulation Resistance:	100MΩ Min
Dielectric Strength:	250VAC 1 minute
Operating Temperature:	-20°C to +70°C
Electrical Life:	100,000+ Cycles
Operating Force:	180gf

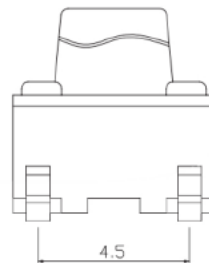

H
4.3
5.0
6.0
7.0
8.0

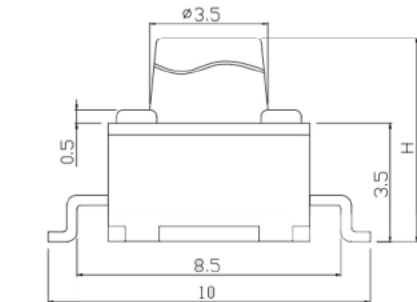
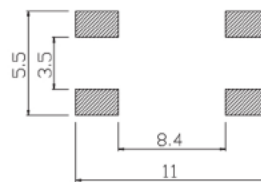
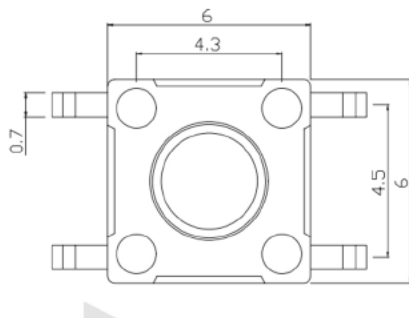

PCB LAYOUT

Description	Ref Code
6x6x8mm SMT Momentary PCB Tactile Switch	483117