



Rating	16A 125VAC, 10A 250VAC 	Mounting Hole
	10A 125VAC, 6A 250VAC CQC	
	10(4)A 250V~ 25T85 	
Contact Resistance	50m ohm Max.	 Thickness:2.0~3.0
Insulation Resistance	DC 500V 100M ohm Min.	
Dielectric Strength	AC 1500V 1 minute	
Operation Temperature	-25°C~85°C	
Switch Function	2P SPST ON-OFF	



Material:
 Frame: Black, Nylon 66
 Actuator: Black/Blue, Nylon 66
 Terminals: Silver plated, Copper Alloy
 Hot stamping: White ,0 -

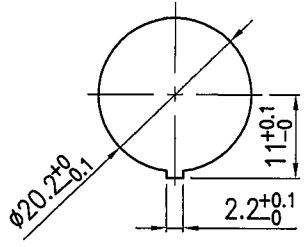
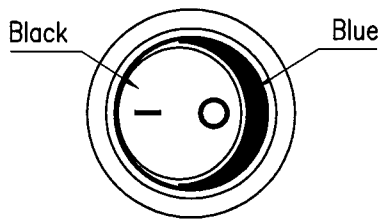
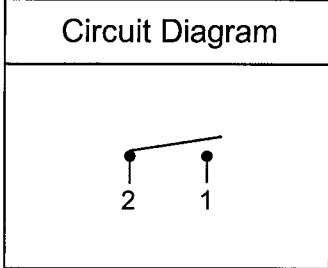
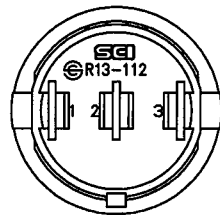
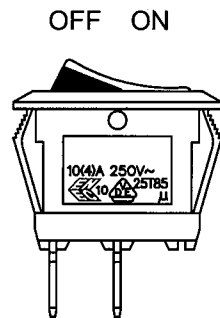
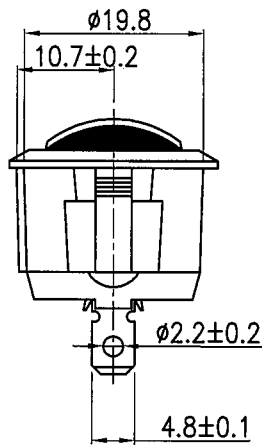
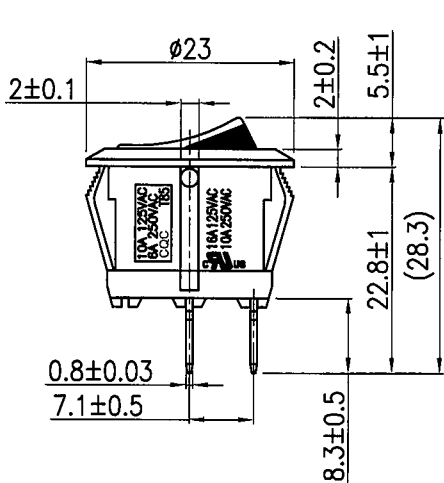

原稿
 2017.9.29
 研發部

1、Tolerances Unless Otherwise Specified ±0.3