

FM series

Snap-in rocker switches •
panel cut-out 19 x 13 (.750 x .508)



DISTINCTIVE FEATURES

For class II appliances

UL approved

Protection against moisture by double-shell case

Illuminated or non-illuminated

Optional sealing boot



ELECTRICAL AND GENERAL SPECIFICATIONS

- Approved ratings (functions 1 and 6) :
UL : 6 A 250 VAC & 125 VAC T 65°C
- Max. contact rating :
 - functions 1 and 6 : see above.
 - function 3 : 4 A 250 VAC
 - functions 8 and 9 : 6 A 250 VAC
- LED types available :
3.3 V (4 V max.) 10 mA LED (resistor to be series connected by the user)
5 V or 12 V LED with integrated resistor
- Initial contact resistance : 20 mΩ max.
- Insulation resistance : 1,000 MΩ min. at 500 VDC
- Dielectric strength :
 - functions 1 and 6 : 2,500 Vrms between terminals
 - functions 3, 8 and 9 : 1,500 Vrms between terminals
- Electrical life at full load : 10,000 cycles
- Operating temperature : -20 °C to +85 °C (-4 °F to +185 °F)



MATERIALS

- Case, frame, rocker : PA6/6
- Contacts : silver
- Terminals : silver plated
- Lens : PC
- Lamp terminal : no plating
- Fluorescent lamp for blue or green lens, neon lamp for other colors
products may be recycled at end-of-life for the re-claiming of valuable metal components.

The company reserves the right to change specifications without notice.



FM series

Snap-in rocker switches •
panel cut-out 19 x 13 (.750 x .508)

AGENCY APPROVALS



Availability : functions 1 and 6.

Marking : approved models are standard marked.



PANEL CUT-OUT

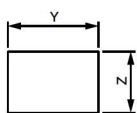

Panel thickness	Dim. Y	Dim. Z
0.75 to 1.25 mm	19.2 +0/-0.1	12.9 +0.15/-0
1.25 to 2 mm	19.4 +0/-0.1	12.9 +0.15/-0
2 to 3 mm	19.8 +0/-0.1	12.9 +0.15/-0



TERMINALS

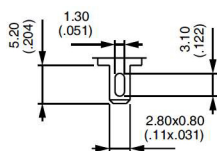

2
Solder lug

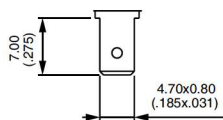

8
Quick-connect

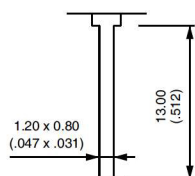

9
Straight PC
(functions 1 and 6 only)

FM series

Snap-in rocker switches •
panel cut-out 19 x 13 (.750 x .508) • non-illuminated



BUILD YOUR PART NUMBER

NON-ILLUMINATED
ILLUMINATED SEE NEXT PAGES

BASIC PART NUMBER

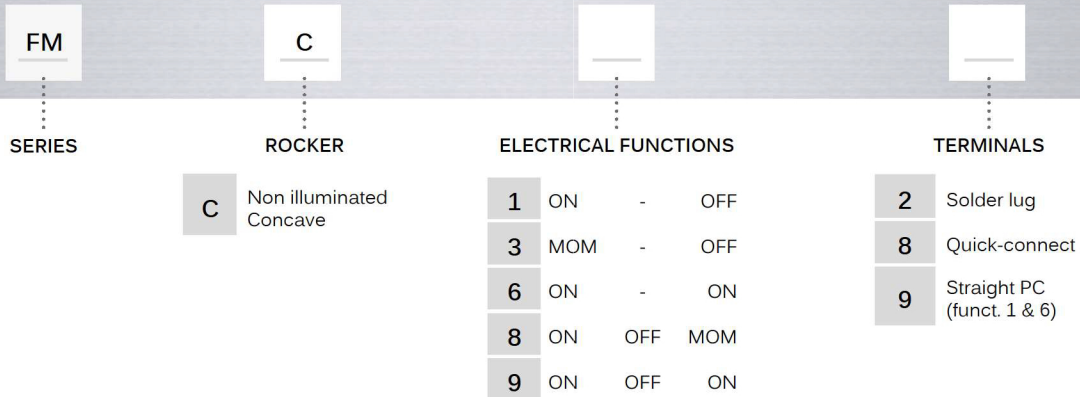

OPTIONS

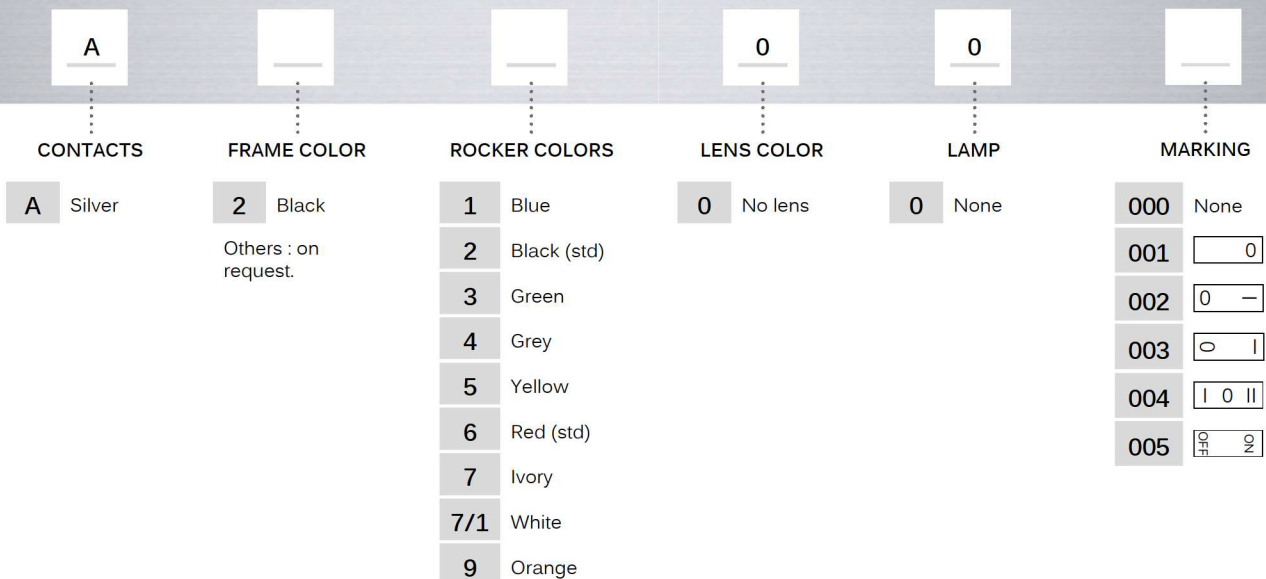

ABOUT THIS SERIES

On the following pages, you will find successively basic part numbers of switches and options in the same order as in above chart.



Notice : please note that not all combinations of above numbers are available. Refer to the following pages for further information.



A **sealing boot** is available to protect the switches against sand or splashing water. Part number U7720. See "Sealing boots" section of website.

FM series

Snap-in rocker switches •
panel cut-out 19 x 13 (.750 x .508) • non-illuminated

NON-ILLUMINATED QUICK-CONNECT TERMINALS



Single pole	1-2		2-3
FMC18	ON	-	OFF
FMC38	MOM	-	OFF
FMC68	ON	-	ON
FMC88	ON	OFF	MOM
FMC98	ON	OFF	ON

For solder lug terminals, replace 8 with 2 (FMC•2)
For straight PC terminals, replace 8 with 9 (FMC•9)

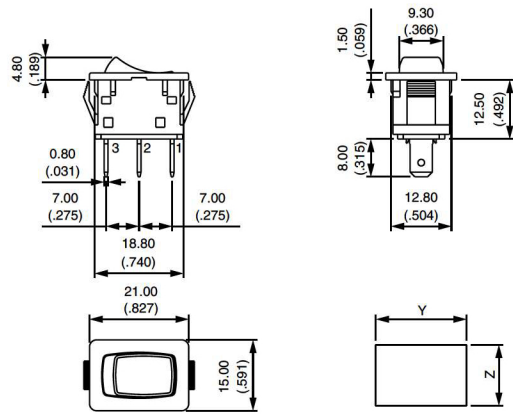

CONTACT MATERIALS

BASIC P/N



A Silver

FRAME COLOR

BASIC P/N



2 Black

Others : on request

ROCKER COLORS

BASIC P/N



- 1 Blue
- 2 Black (std)
- 3 Green
- 4 Grey
- 5 Yellow
- 6 Red (std)
- 7 Ivory
- 7/1 White
- 9 Orange

LENS COLOR

BASIC P/N



0 No lens

FM series

Snap-in rocker switches •
panel cut-out 19 x 13 (.750 x .508) • non-illuminated

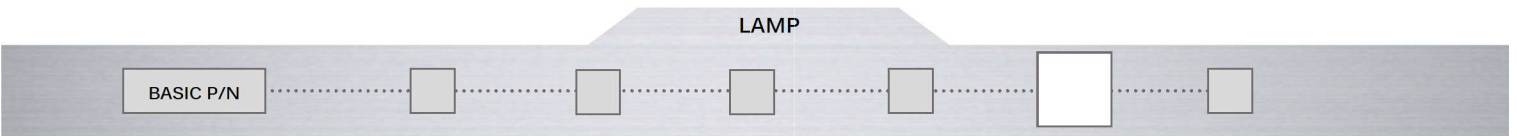

0 None

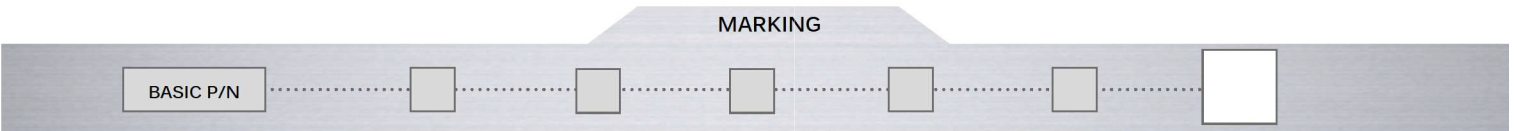

Color of marking : white for black rockers - black for other colors - Other : on request.

000 None

001

0

002

0 -

003

○

004

0

005

○	○
≡	≡

FM series

Snap-in rocker switches •
panel cut-out 19 x 13 (.750 x .508) • illuminated

BUILD YOUR PART NUMBER

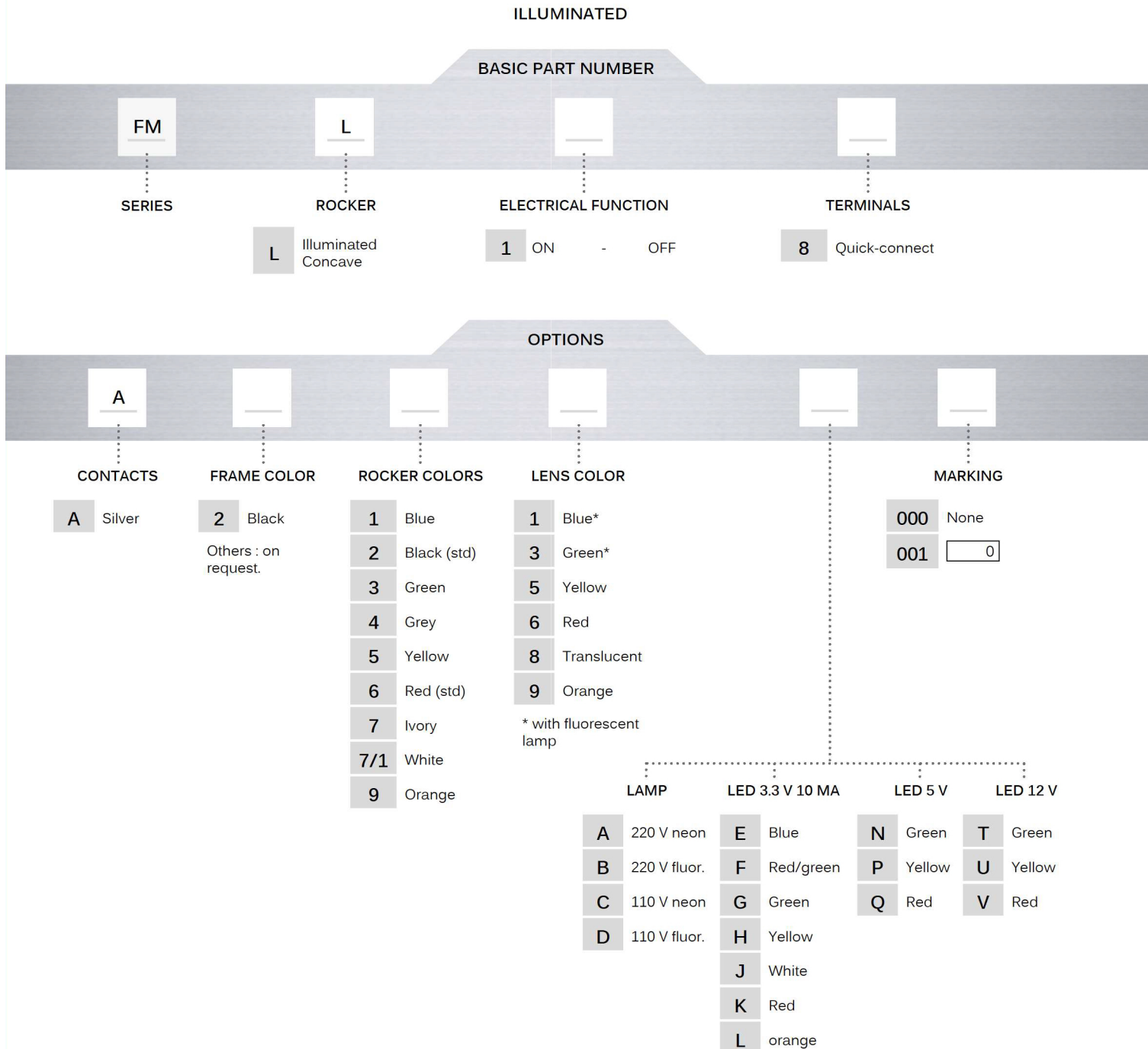



** Resistor value = $\frac{\text{supply voltage} - \text{LED forward voltage}}{\text{LED forward current}}$

No resistor**

ABOUT THIS SERIES

On the following pages, you will find successively basic part numbers of switches and options in the same order as in above chart.

-  **Notice** : please note that not all combinations of above numbers are available. Refer to the following pages for further information.
-  **A sealing boot** is available to protect the switches against sand or splashing water. Part number U7720. See "Sealing boots" section of website.

FM series

Snap-in rocker switches • panel cut-out 19 x 13 (.750 x .508) • illuminated

ILLUMINATED QUICK-CONNECT TERMINALS



Single pole
FML18 ON - OFF

For LED models, terminal 2 = cathode (-), terminal 3 = anode (+)

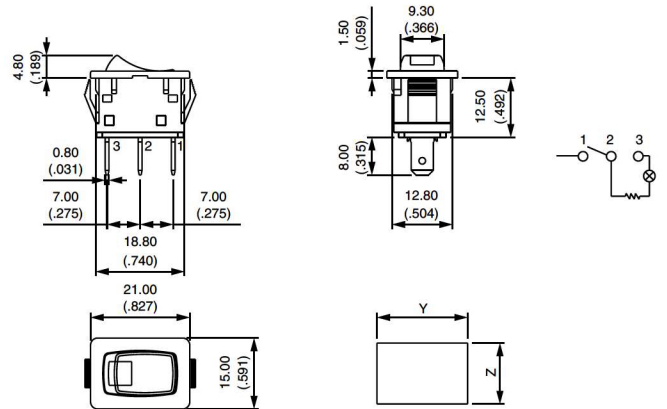

CONTACT MATERIALS

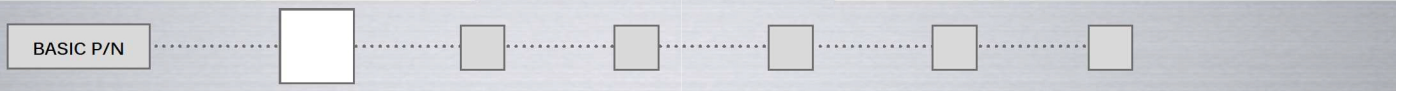

A Silver

FRAME COLOR

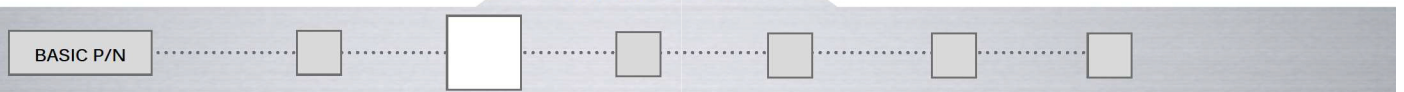

2 Black
Others : on request

ROCKER COLORS



- 1 Blue
- 2 Black (std)
- 3 Green
- 4 Grey
- 5 Yellow
- 6 Red (std)
- 7 Ivory
- 7/1 White
- 9 Orange

LENS COLORS



- 1 Blue *
 - 3 Green *
 - 5 Yellow
 - 6 Red
 - 8 Translucent
 - 9 Orange
- * with fluorescent lamp

FM series

Snap-in rocker switches •
panel cut-out 19 x 13 (.750 x .508) • illuminated

LAMPS / LEDS



LAMP

A	220 V neon
B	220 V fluorescent
C	110 V neon
D	110 V fluorescent

LED 3.3 V 10 mA

E	Blue
F	Red/green
G	Green
H	Yellow
J	White
K	Red
L	Orange
No resistor **	

LED 5 V

N	Green
P	Yellow
Q	Red

LED 12 V

T	Green
U	Yellow
V	Red

** Resistor value = $\frac{\text{supply voltage} - \text{LED forward voltage}}{\text{LED forward current}}$

MARKING



Color of marking : white for black rockers - black for other colors - Other : on request.

000 None

001