

FP series

Fully illuminated pushbutton switches •
bushing Ø 24 mm • momentary or latching



DISTINCTIVE FEATURES

- Threaded bushing
- Full actuator or symbol illumination
- Large but lightweight
- Sealed to IP69K
- Pad printed or laser etched symbols



ENVIRONMENTAL SPECIFICATIONS

- Front panel sealing : IP69K according to DIN 40050-9
- Optional back panel sealing : IP67
- Operating temperature : -40 °C to +75 °C (-40 °F to +167°F)



ELECTRICAL SPECIFICATIONS

- Max. current/voltage rating with resistive load :
 - silver contacts (code 2) : 4 A 12 VDC
 - gold plated contacts (code 4) : 200 mA 12 VDC
- Initial contact resistance : 50 mΩ max.
- Insulation resistance : 1 GΩ min. at 500 VDC
- Dielectric strength : 1,000 Vrms 50 Hz min.
- Electrical life at full load :
 - Momentary models : 1 million cycles (gold plated contacts)
400,000 cycles (silver contacts)
 - Latching models : 200,000 cycles

LED COMPONENT SPECIFICATIONS

LED color	Forward current	Typ. forward voltage	Max. forward voltage
Blue (A)	20 mA	3.3 V	4 V
Green (B)	20 mA	2.1 V	2.5 V
Red (C)	20 mA	1.9 V	2.5 V
Yellow (D)	20 mA	2 V	2.5 V
White (E)	20 mA	3.3 V	4 V
Red/green (F)	20 mA	1.9 V / 2.1 V	2.5 V / 2.5 V
Red/blue (G)	20 mA	1.9 V / 3.3 V	2.5 V / 4 V
White/blue (L)	20 mA	3.3 V / 3.3 V	4 V / 4 V

A resistor must be series-connected by the user

$$\text{Resistor value} = \frac{\text{supply voltage} - \text{LED forward voltage}}{\text{LED forward current}}$$

The company reserves the right to change specifications without notice.



FP series

Fully illuminated pushbutton switches •
bushing Ø 24 mm • momentary or latching



GENERAL SPECIFICATIONS

- Panel thickness : 1(.039) to 18 mm (.708) max.
- Total travel : 2.5 mm ± 0.5 mm
- Typical operating force : 8 N ± 2 N
- Low level or mechanical life :
 - Momentary models : 1 million cycles
 - Latching models : 200,000 cycles
- Torque : 3 Nm max. applied to nut



MATERIALS

- Case : PA46
- Actuator : PA12
- Bushing/ bezel : PA66
- Contacts : silver (code 2) or silver, gold plated (code 4)
- Cable : length 300 mm, section depending on switch model
- Terminal seal : epoxy or overmolding

SOCOJE products may be recycled at end-of-life for the re-claiming of valuable metal components



PANEL CUT-OUT

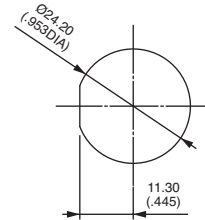

WIRING DIAGRAM

→ FLAT

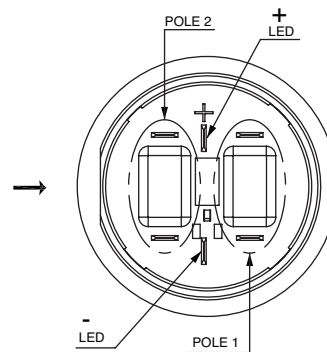

FP series

Fully illuminated pushbutton switches • bushing Ø 24 mm • momentary or latching

BUILD YOUR PART NUMBER

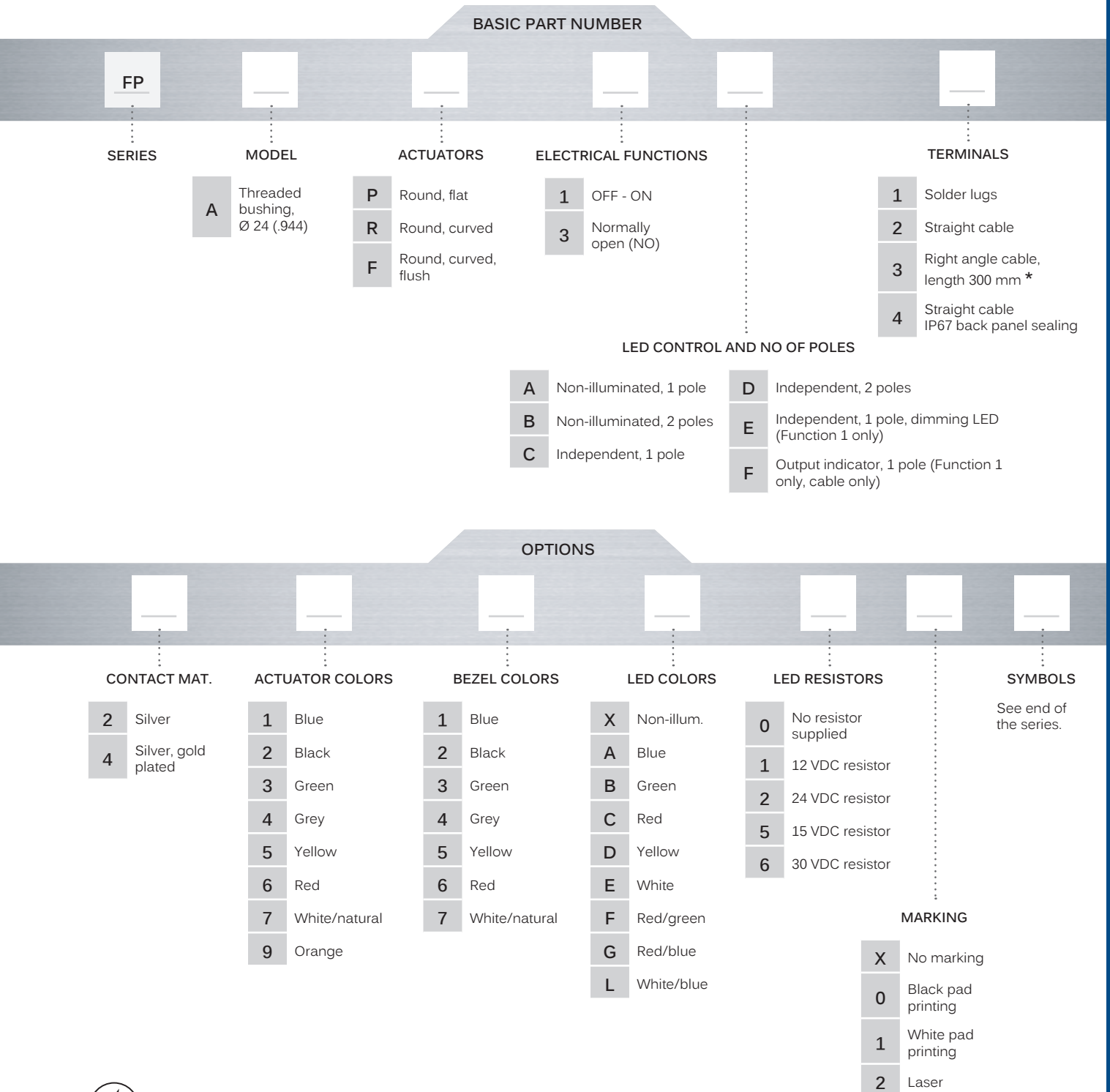

ABOUT THIS SERIES

On the following pages, you will find successively basic part numbers of switches and options in the same order as in above chart.

Notice : please note that not all combinations of above numbers are available. Refer to the following pages for further information.

Mounting accessories : Standard hardware supplied : 1 hex nut and 1 O-Ring

* Option not compatible with « D » LED control and No of poles.

FP series

Fully illuminated pushbutton switches •
bushing Ø 24 mm • momentary or latching

SOLDER LUG TERMINALS



	LATCHING		
Curved actuator	FPAR1•1	OFF	ON
Flat actuator	FPAP1•1	OFF	ON
	MOMENTARY (NO)		
Curved actuator	FPAR3•1		
Flat actuator	FPAP3•1		



STRAIGHT CABLE TERMINALS



	LATCHING		
Curved actuator	FPAR1•2	OFF	ON
Flat actuator	FPAP1•2	OFF	ON
	MOMENTARY (NO)		
Curved actuator	FPAR3•2		
Flat actuator	FPAP3•2		



RIGHT ANGLE CABLE TERMINALS



	LATCHING		
Curved actuator	FPAR1•3	OFF	ON
Flat actuator	FPAP1•3	OFF	ON
	MOMENTARY (NO)		
Curved actuator	FPAR3•3		
Flat actuator	FPAP3•3		



STRAIGHT CABLE TERMINALS IP67 BACK PANEL SEALING



	LATCHING		
Curved actuator	FPAR1•4	OFF	ON
Flat actuator	FPAP1•4	OFF	ON
	MOMENTARY (NO)		
Curved actuator	FPAR3•4		
Flat actuator	FPAP3•4		



→ FLAT

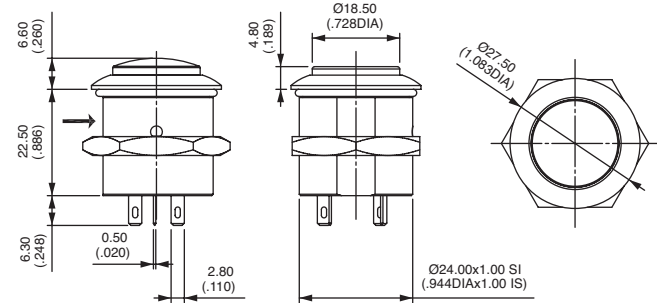

→ FLAT

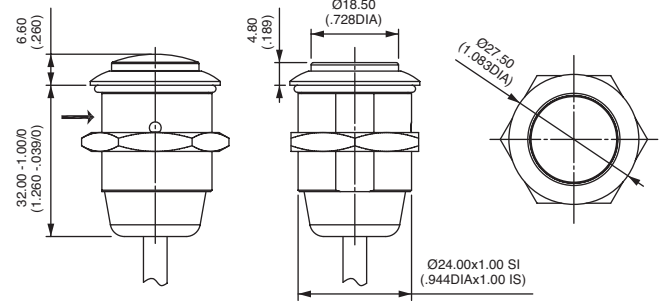

→ FLAT

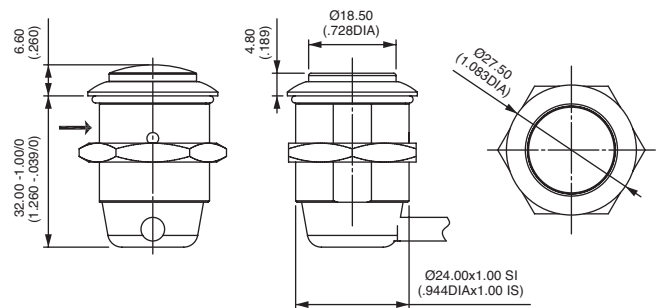

→ FLAT

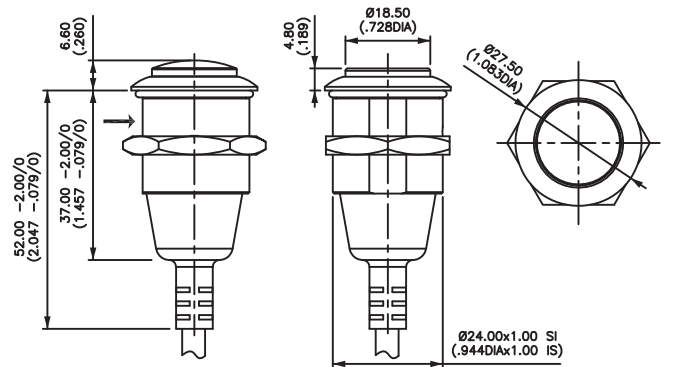

To order a product, replace • with one of the codes selected under “LED control and number of poles” on next page, then add the desired options.

Fully illuminated pushbutton switches •
bushing Ø 24 mm • momentary or latching

LED CONTROL AND NUMBER OF POLES

Complete the model numbers on previous pages with one of the following codes.

	Function 1 (latching)	Function 3 (momentary)
Non-illuminated one pole A		
Non-illuminated two poles B		
Independent one pole C		
Independent two poles D		
Independent one pole Dimming LED E		-
Output indicator, one pole Cable only F		-

dotted line = jumper to be wired by the user. LED- has to be wired to one pin of pole 2.

CONTACT MATERIALS

BASIC P/N

- 2 Silver
- 4 Silver, gold plated

ACTUATOR COLORS

BASIC P/N

- 1 Blue
- 2 Black
- 3 Green
- 4 Grey
- 5 Yellow
- 6 Red
- 7 White/natural
- 9 Orange

FP series

Fully illuminated pushbutton switches •
bushing Ø 24 mm • momentary or latching

BEZEL COLORS

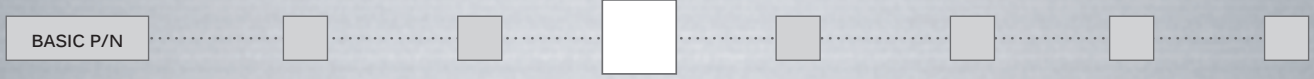

- | | | | |
|---|-------|---|---------------|
| 1 | Blue | 5 | Yellow |
| 2 | Black | 6 | Red |
| 3 | Green | 7 | White/natural |
| 4 | Grey | | |

LED COLORS

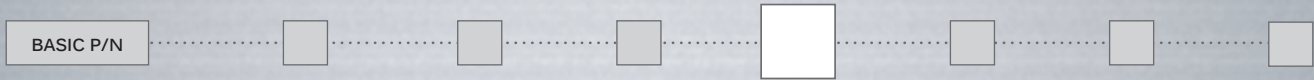

- | | | | |
|---|-----------------|---|-----------|
| X | Non-illuminated | D | Yellow |
| A | Blue | F | Red/green |
| B | Green | G | Red/blue |
| C | Red | | |

LED RESISTOR

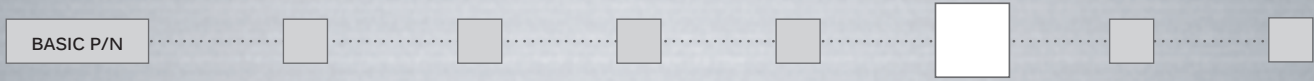

- | | |
|---|----------------------|
| 0 | No resistor supplied |
| 1 | 12 VDC resistor |
| 2 | 24 VDC resistor |
| 5 | 15 VDC resistor |
| 6 | 30 VDC resistor |

MARKING



- | | | | |
|---|--------------------|---|--------------------|
| X | No marking | 1 | White pad printing |
| 0 | Black pad printing | 2 | Laser |

SYMBOLS

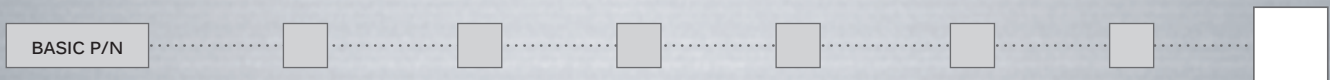

Blank No symbol

Available symbols

Complete the enlarged box with the one of the codes listed on the following pages.

Marking color

White marking for illuminated actuators (laser etching) and non-illuminated black actuators (pad printing). Black marking for non-illuminated color actuators (pad printing). Other : on request.

Marking area

The symbol will be included in the hatched area.

MARKING AREA

→ FLAT

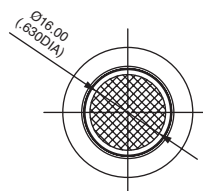

FP range

Symbols for fully illuminated pushbutton switches



Most symbols meet the ISO 7000 standard “graphical symbols for use on equipment” (code given in bracket in the description).

Contact us for symbols not featured in the following tables.

CODE	SYMBOL	DESCRIPTION
XX	None	-
01	ON	-
02	OFF	-
03	○	-
04	I	-
05	II	-
06	STOP	-
07	A	Stop
08	M	Motion
09	▲	Up motion
10	▼	Down motion
11	☀	Hot
12	❄	Cold
13	⚠	Hazard warning (0085)
14	☀	Traveller lighting
15	☀	Driver lighting (1421)

CODE	SYMBOL	DESCRIPTION
16	☀	Revolving light
17	☰	Rear ventilator
18	☀	Heating (0637)
19	🚪	Door opening
20	☀	Windshield demister/defroster (0635)
21	☀	Windshield wiper (0086)
22	☀	Windshield washer (0088)
23	☀	Ventilator fan (0089)
24	☀	Side mirror defroster
25	⚙	Restarting pump
26	☀	Front fog lights (0633)
27	☀	Rear fog lights (0634)
28	🚗	Propulsion system trim
29	☀	Beacon (1141)
30	⚓	Anchor
31	🔌	Electric motor (0011)

CODE	SYMBOL	DESCRIPTION
32	🚑	Emergency first aid vehicle (2565)
33	🚛	Load tipping (1557)
34	🚛	Loading light (2457)
35	🚜	Tractor, rear-ward (1667)
36	🚛	Combine, direction of movement (1678)
37	🚛	Use no forks (2406)
38	⚙	Transmission (1166)
39	☀	Working spot light (1145)
40	🚗	Engine (0640)
41	📢	Horn (0244)
42	🔒	Lock (1656)
43	TAXI	Taxi sign light (2551)
44	☀	Working light (1204)
45	☀	Working light symmetric (1204)
46	🚗	-
47	ASM	-

















FP range





Symbols for fully illuminated pushbutton switches

CODE	SYMBOL	DESCRIPTION	CODE	SYMBOL	DESCRIPTION	CODE	SYMBOL	DESCRIPTION
48		All wheel drive	69		Engine idle control	90		ECAS reset
49		Differential lock (1662)	70		Cruise res/set	91		Driver windows heating
50		-	71		Driver windows up/down	92		Cruise set
51		-	72		Middle door opening	93		Air bag up/down
52		-	73		Front door opening	94		Read lighting
53		-	74		Lighting in baggage room	95		Lighting main switch
54		Rear window wiper (0097)	75		Cruise on/off	96		Heating using water
55		Rear window washer (0099)	76		TV	97		Low beam
56		Lower load (2223)	77		Pump	98		Position lights
57		Cab lock (1560)	78		Toilet	99		Diesel acceleration
58		Extraction	79		Toilet decontamination	A1		Manual mode
59		Pumping in	80		Front windshield heating	A2		Clockwise cabin rotation
60		Rear PTO (1572)	81		Aus	A3		Anticlockwise cabin rotation
61		Front PTO	82		Radiator fan	A4		-
62		Rockshaft down	83		Remove retarder	A5		-
63		Rockshaft up	84		Restricted speed	A6		Parking brake
64		Indicator	85		Preheater	A7		-
65		Brake release	86		ABS detection	A8		-
66		Baggage room left door	87		ECAS detection	A9		-
67		Baggage room right door	88		Engine stop	AA		-
68		Power blinds	89		Cruise res/cancel	AB		-

FP range

Symbols for fully illuminated pushbutton switches

CODE	SYMBOL	DESCRIPTION
AC		-
AD		-
AE		-
AF		-
AG		Battery charging condition (0247)
AH		Turn signals (0084)
AJ		High beam (0082)
AK		Differential lock, bogie (2600)
AL		Brushing with a rotating brush (0070)
AM		Differential lock, transfer case 4x4 (2475)
AN		Loader bucket, float (1441)
AP		Loader bucket (1437)
AQ		Rear window washer & wiper (0098)
AR		Header, Header drive (1579)
AS		Excavator/backhoe boom side shift (2091)
AT		Chemical water treatment (1851)
AU		Grapple skidder, single funct° boom (1762)

CODE	SYMBOL	DESCRIPTION
AV		-
AW		-
AY		-
AZ		-
B1	HIGH	-
B2	LOW	-
B3		-

Legend scale

Depending on space available on the product (see "Symbols" section at the end of each series).