

Specifications

Rating:	5A 250VAC
Protection Level:	IP65
LED illumination:	12V
Housing Material:	Stainless Steel
Contacts:	1NO/1NC
Contact Resistance:	50mΩ Max
Insulation Resistance:	1000MΩ Min
Dielectric Strength:	2000VAC 1 minute
Operating Temperature:	-25°C to +85°C

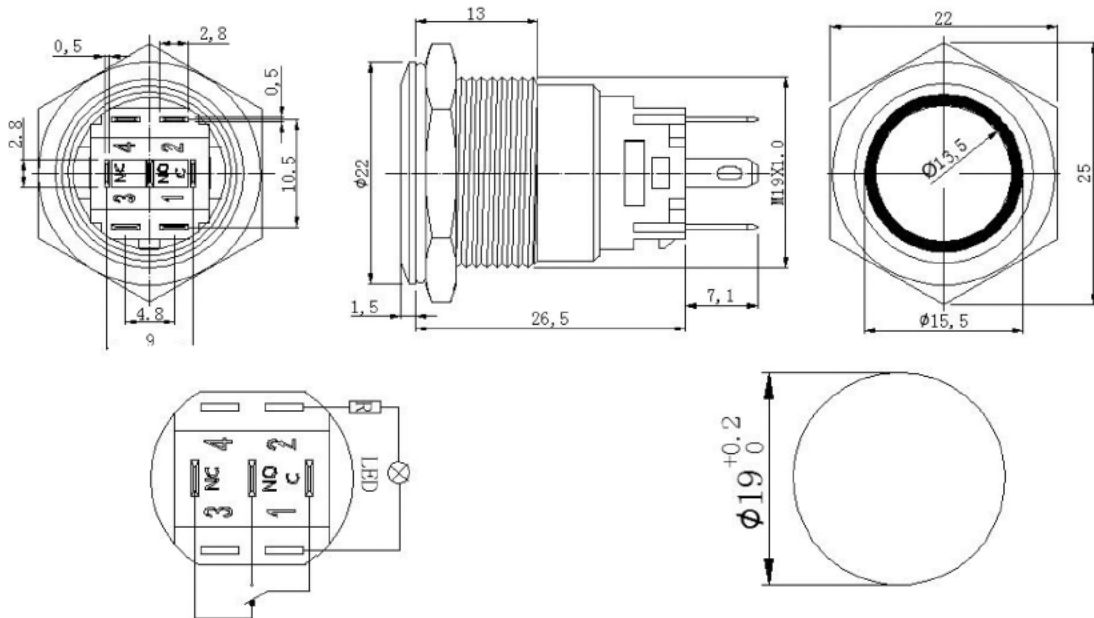

Description	Ref Code
Green LED On-(On) 19mm Vandal Resistant Push Switch SPST	481600