

IR series

Sealed pushbutton switches • bushing Ø 16 mm • momentary • standard version



DISTINCTIVE FEATURES

- Screw version up to 4 A
- Tactile feedback
- Sealed to IP67
- Illuminated or non-illuminated
- Flat round actuator for optional marking



ENVIRONMENTAL SPECIFICATIONS

- Front panel sealing : IP67 according to IEC 60529
- Shock resistance : 100 g according to IEC 512-4, test 6c
- Vibration resistance : 10-500Hz - 10 g according to IEC 512-4, test 6d
- Salt spray : IEC 512-6, test 11f
- Operating temperature : -40°C to +85°C (-40 °F to +185 °F)



ELECTRICAL SPECIFICATIONS

- Max. current/voltage rating with resistive load :
 - Gold plated contacts: Code 4 : 200 mA 48 VDC, 500,000 cycles
Code 7 : 5 A 28 VDC, 70,000 cycles
 - Silver contacts (code 2) - screw terminals : 4 A 48 VDC, 500,000 cycles
- Initial contact resistance : 100 mΩ max.
- Insulation resistance : 1 GΩ min. at 500 VDC
- Dielectric strength : 1,500 Vrms



LED COMPONENT SPECIFICATIONS

| LED color | Forward current | Typ. forward voltage | Max. forward voltage |
|-------------------|-----------------|----------------------------|----------------------|
| Super red (0S) | 20 mA | 2.1 V | 2.3 V |
| Yellow (0Y) | 20 mA | 2.1 V | 2.3 V |
| Green (0G) | 20 mA | 2.1 V | 2.3 V |
| Blue (0B) | 20 mA | 3.2 V | 3.8 V |
| White (0W) | 20 mA | 3.35 V | 4.25 V |
| Red/Green (SG) | 20 mA | Red: 1.95 V / green: 2.1 V | 2.5 V |
| Yellow/green (YG) | 20 mA | Yellow: 2 V / green: 2.1 V | 2.5 V |

A resistor must be series-connected by the user.

$$\text{Resistor value} = \frac{\text{supply voltage} - \text{LED forward voltage}}{\text{LED forward current}}$$

On flying lead versions, the LED resistor can be integrated by SOCOJE on request.

The company reserves the right to change specifications without notice.

IR series

Sealed pushbutton switches • bushing Ø 16 mm • momentary • standard version



GENERAL SPECIFICATIONS

- Panel thickness : 8 mm (.314) max.
- Total travel : 1.6 mm (.062) ± 0.3 mm
- Typical operating force : 4 N ± 2 N
- Low level or mechanical life : 1,000,000 cycles
- Torque : 0.8 Nm max. applied to nut
- Soldering : 320 °C (608 °F) max. for 3 sec.



MATERIALS

- Case : thermoplastic UL94-V0
- Actuator : polyamide 6/6
- Bushing/bezel : polyamide 6/6
- Contacts : 4 and 7 : silver, gold plated
2 : silver (screw terminals)
- Multi-wire lead AWG20, section 0.6 mm²
- LED wire : AWG26, section 0.12 mm²
- Lens : polycarbonate
- Terminal seal : epoxy



MOUNTING

PANEL CUT-OUT

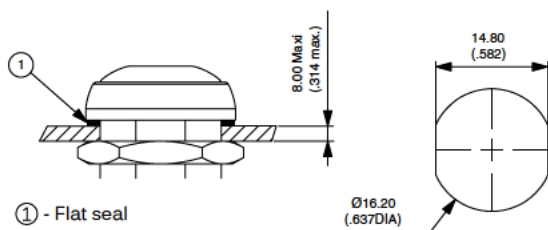

MATRIX MOUNTING

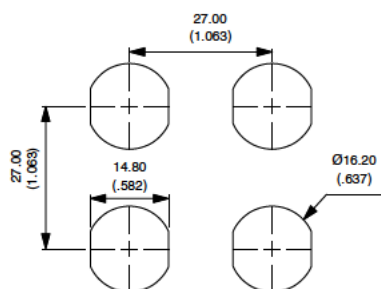

TERMINALS

ILLUMINATED MODELS



NON-ILLUMINATED MODELS

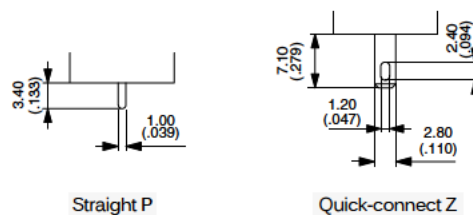

ELECTRICAL FUNCTIONS

ILLUMINATED MODELS

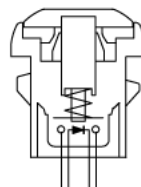

Function 3 (NO)

NON-ILLUMINATED MODELS

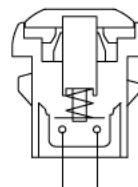

Function 3 (NO)

Sealed pushbutton switches • bushing Ø 16 mm • momentary • standard version

BUILD YOUR PART NUMBER

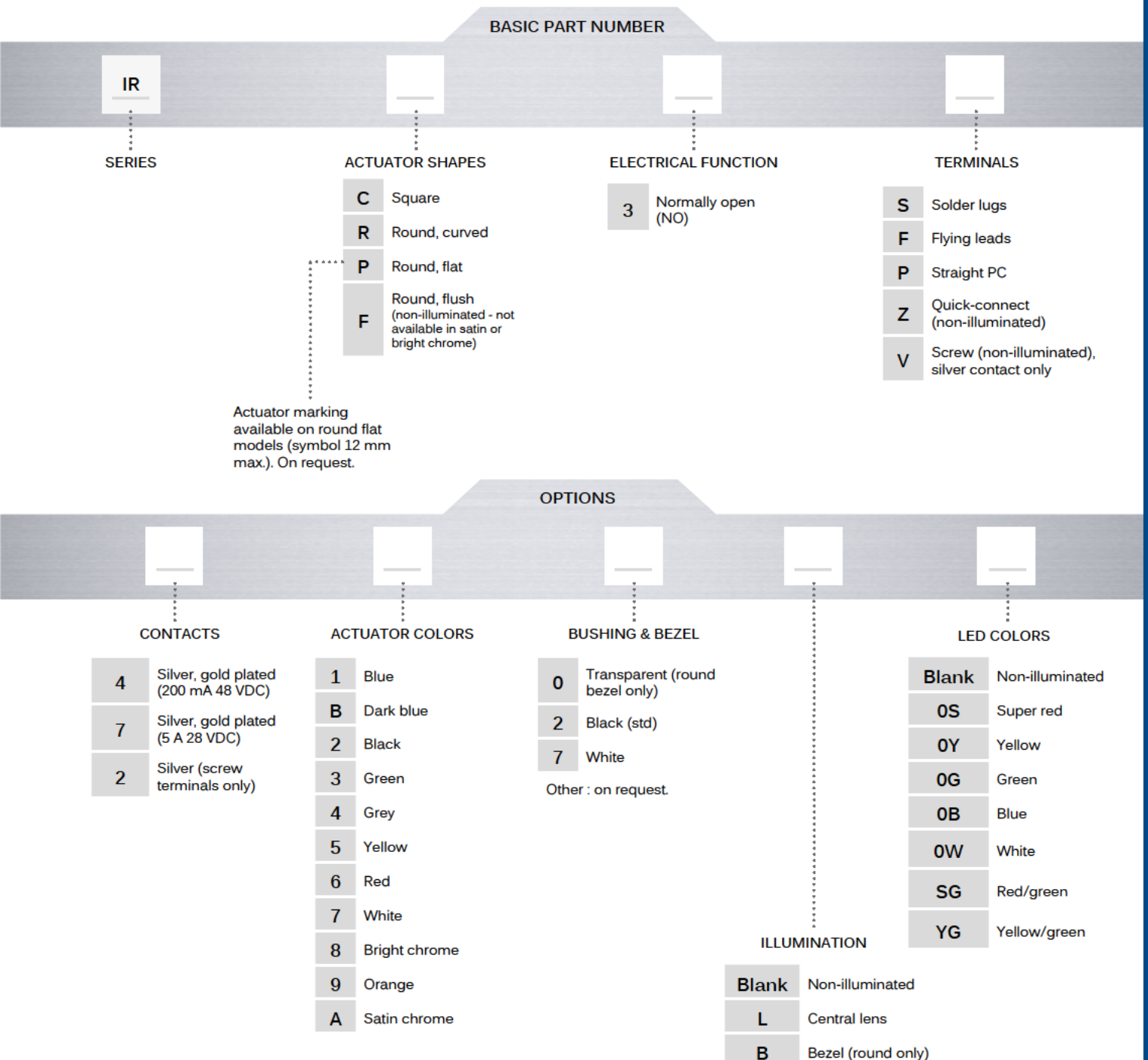

ABOUT THIS SERIES

On the following pages, you will find successively basic part numbers of switches and options in the same order as in above chart.

- Notice** : please note that not all combinations of above numbers are available. Refer to the following pages for further information.
- A **sealing boot** is available to protect the switches against frost and sand (P/N U7125). Round models only. See "Sealing Boot" section of website.
- Mounting accessories** : Standard hardware supplied : 1 hex nut 19 mm (.748) across flats and 1 flat seal. Hex nut P/N U6715.

IR series

Sealed pushbutton switches • bushing Ø 16 mm • momentary • standard version

ROUND - ILLUMINATED SOLDER LUG TERMINALS

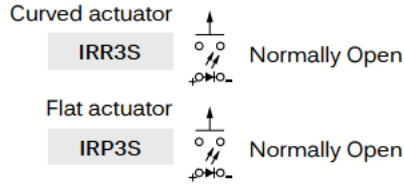

Also available with straight PC terminals : IR•3P.
 LED color is indicated by the bottom of the switch.

ROUND - ILLUMINATED FLYING LEAD TERMINALS

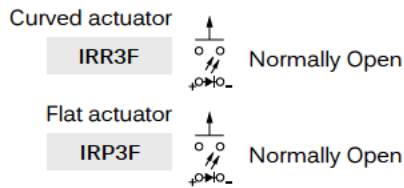

Wire colors : black : NO contact, red : LED anode (+), blue : LED cathode (-)

ROUND - NON-ILLUMINATED SOLDER LUG TERMINALS

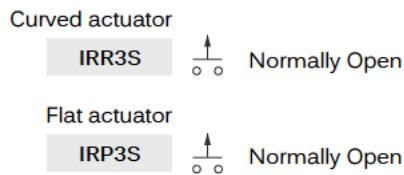

Also available with straight PC terminals : IR•3P
 and quick-connect terminals : IR•3Z.

ROUND - NON-ILLUMINATED FLYING LEAD TERMINALS

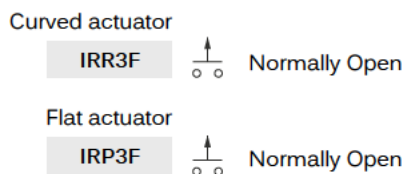

→ FLAT

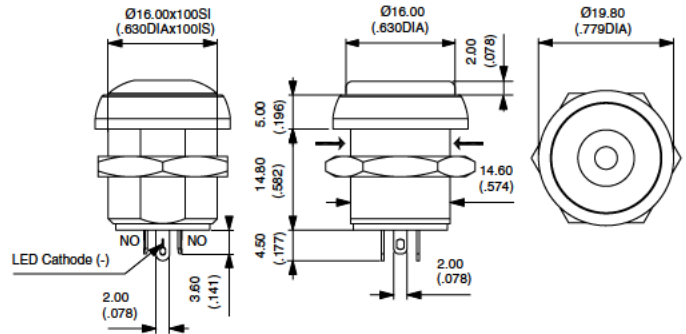

→ FLAT

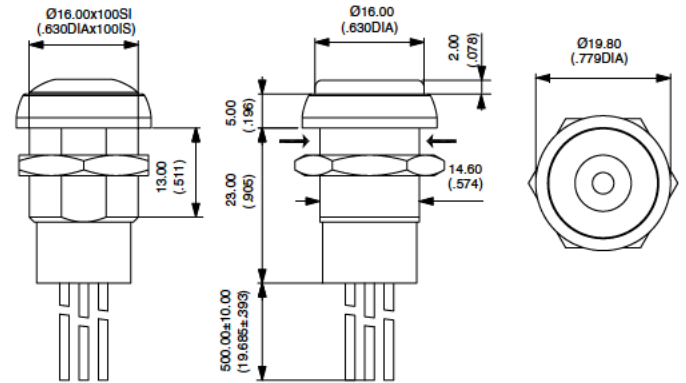

→ FLAT

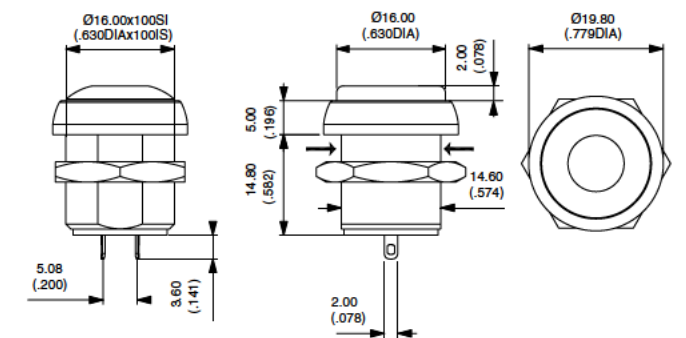

→ FLAT

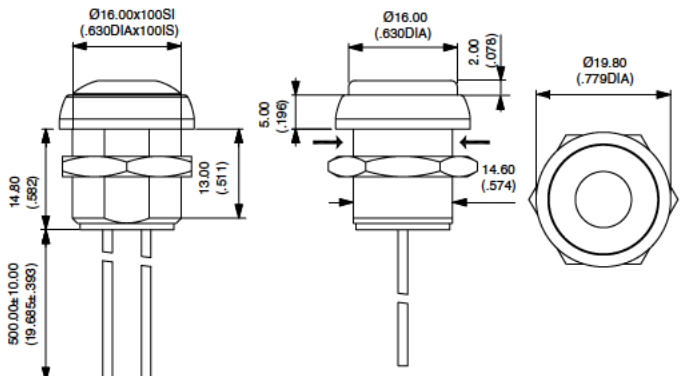

Sealed pushbutton switches • bushing \varnothing 16 mm • momentary • standard version

ROUND - NON-ILLUMINATED SCREW TERMINALS

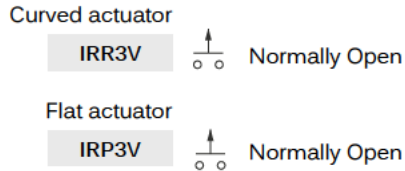

→ FLAT

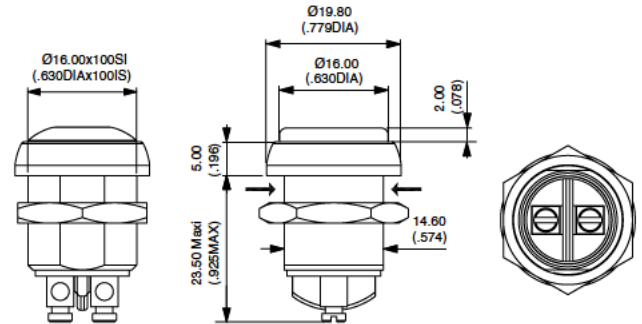

SQUARE - ILLUMINATED SOLDER LUG TERMINALS

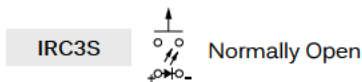

→ FLAT

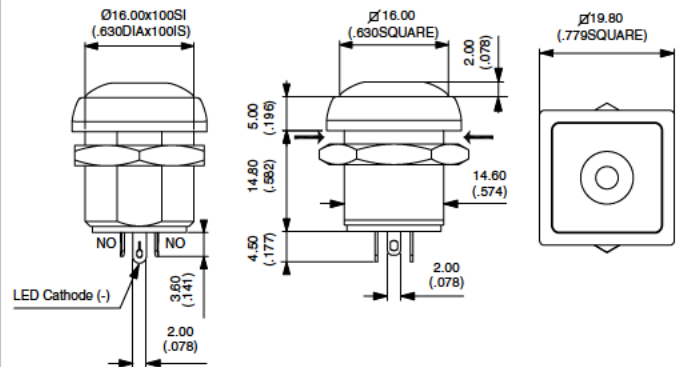

Also available with straight PC terminals : IRC3P.
LED color is indicated by the bottom of the switch.

SQUARE - ILLUMINATED FLYING LEAD TERMINALS

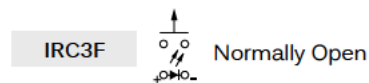

→ FLAT

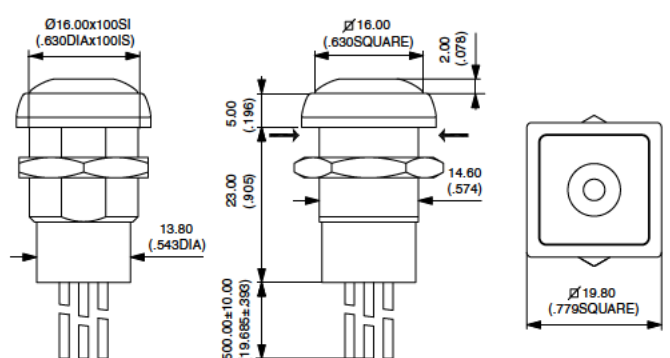

Wire colors : black : NO contact, red : LED anode (+), blue : LED cathode (-)

SQUARE - NON-ILLUMINATED SOLDER LUG TERMINALS



→ FLAT

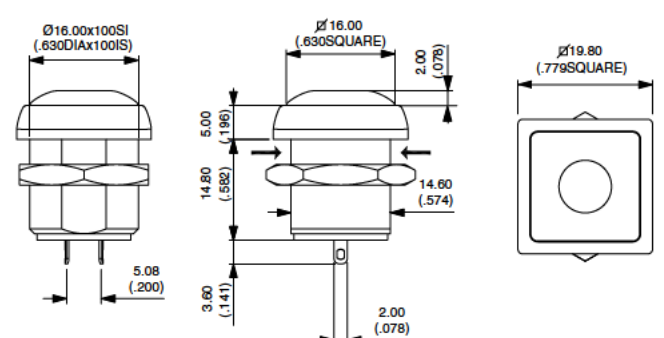

Also available with straight PC terminals : IRC3P
and quick-connect terminals : IRC3Z.

IR series

Sealed pushbutton switches • bushing Ø 16 mm • momentary • standard version

SQUARE - NON-ILLUMINATED FLYING LEAD TERMINALS



IRC3F  Normally Open

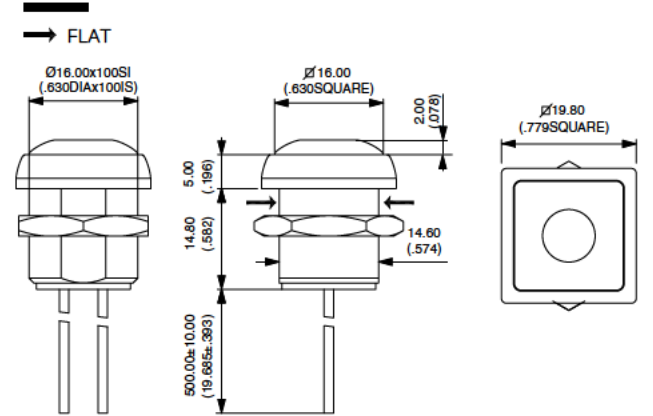

SQUARE - NON-ILLUMINATED SCREW TERMINALS



IRC3V  Normally Open

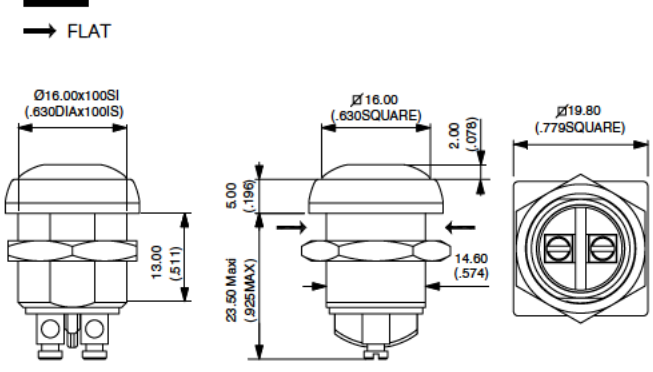

CONTACTS

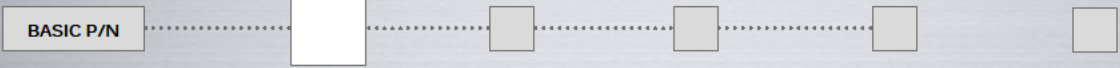

- 4 Silver, gold plated (200 mA 48 VDC)
- 7 Silver, gold plated (5 A 28 VDC)
- 2 Silver (screw terminals only)

ACTUATOR COLORS



- 1 Blue
- B Dark blue
- 2 Black
- 3 Green
- 4 Grey
- 5 Yellow
- 6 Red
- 7 White
- 8 Bright chrome
- 9 Orange
- A Satin chrome

IR series

Sealed pushbutton switches • bushing Ø 16 mm •
momentary • standard version

BUSHING AND BEZEL



- 2 Black (standard)
- 7 White
- 0 Transparent (round bezel only)

ILLUMINATION

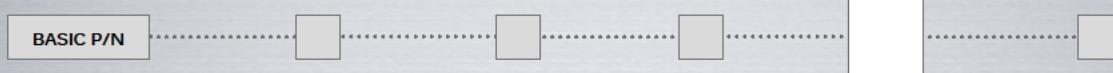

- L Central lens
- B Bezel (round only)

LED COLORS

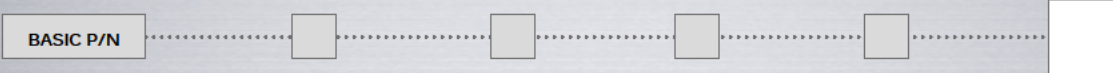

- 0S Super red
- 0Y Yellow
- 0G Green
- 0B Blue
- 0W White
- SG Red/green
- YG Yellow/green