

# PHAP5-50 series

Tact switches • 12 x 12 mm standard package



## DISTINCTIVE FEATURES

- Positive tactile feed back
- Through hole or SMT
- Square or round coloured cap options



## ENVIRONMENTAL SPECIFICATIONS

- Operating Temperature: -25 °C to +70 °C (-13 °F to +158 °F)
- Storage Temperature: -30 °C to +80 °C (-22 °F to +176 °F)



## ELECTRICAL SPECIFICATIONS

- Contact rating: 50 mA 12 VDC
- Contact Resistance: 100 mΩ max.
- Insulation Resistance: 100 MΩ min. at 500 VDC
- Dielectric Strength: 250 VAC / 1 minute



## MECHANICAL SPECIFICATIONS

- Operating force: 160 g ±50 g, 260 g ±50 g
- Mechanical life:
  - 100,000 cycles min. for 260 g
  - 200,000 cycles min. for 160 g
- Travel: 0.35 mm



## MATERIALS

- Body: Nylon
- Contact: Silver plated phosphor bronze
- Cover: Stainless Steel
- Terminal: Silver plated brass
- Actuator: Nylon

The company reserves the right to change specifications without notice.



# PHAP5-50 series

Tact switches • 12 x 12 mm standard package



## PCB LAYOUT

### 50V THROUGH-HOLE

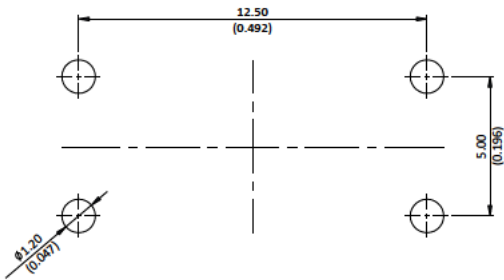

### 50V SURFACE MOUNT

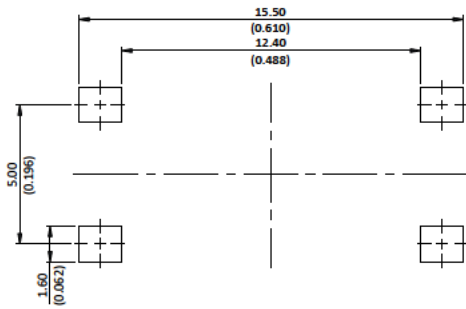

## CIRCUITS

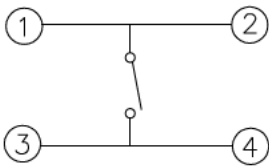

## PACKAGING

PART NUMBER	PACKAGING QUANTITY		
	BAG	TUBE	TAPE AND REEL
PHAP5-50V••T•••	500 pcs	40 pcs	
PHAP5-50V•2A•S••	-	40 pcs	100 pcs
PHAP5-50V•2K•S••		40 pcs	500 pcs
PHAP5-50V•2Q••		40 pcs	400 pcs

# PHAP5-50 series

Tact switches • 12 x 12 mm standard package



## BUILD YOUR PART NUMBER

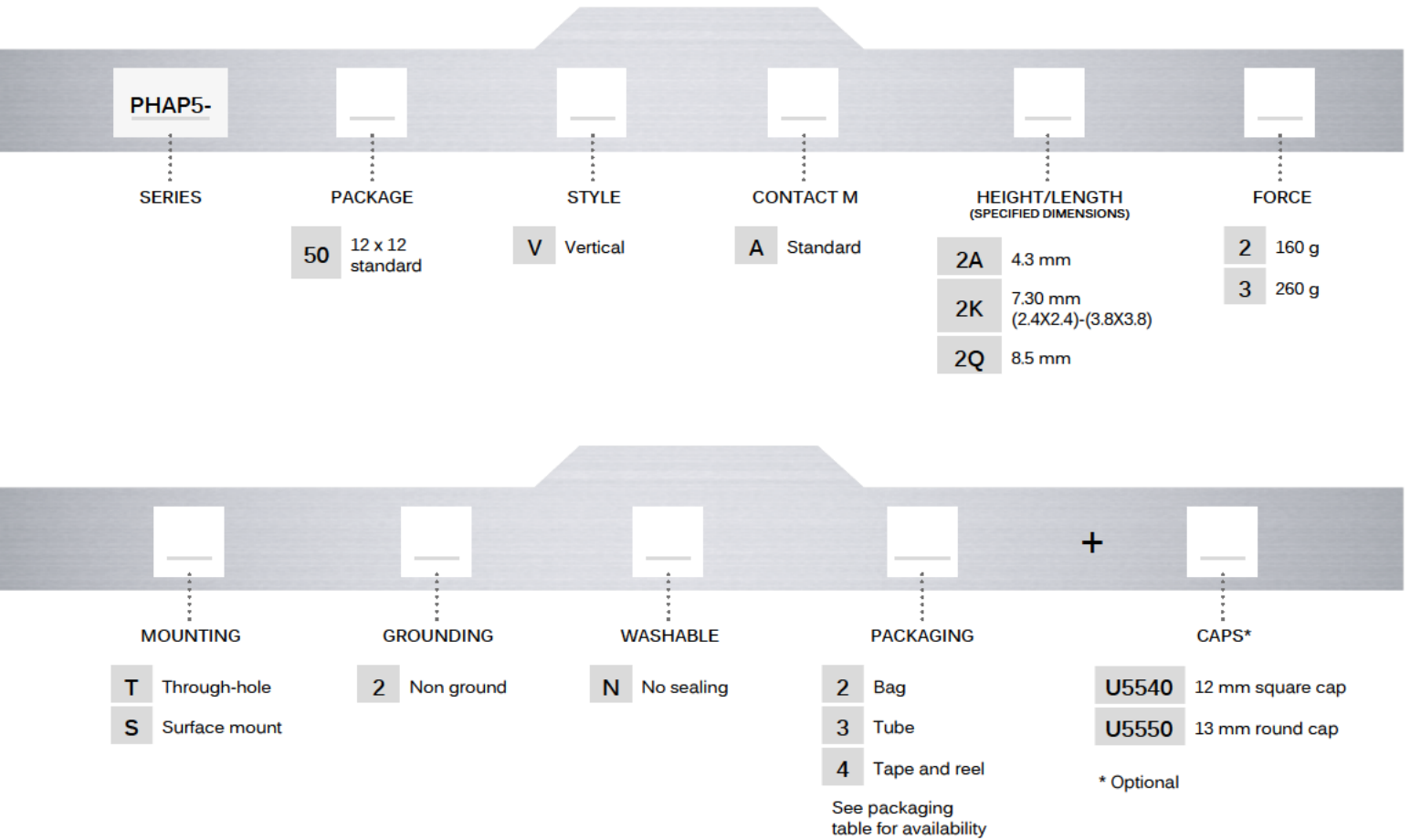

# PHAP5-50 series

Tact switches • 12 x 12 mm standard package

## 50V: 12 X 12 MM - VERTICAL - THROUGH-HOLE



	Height H
PHAP5-50VA2A	4.30 (0.169)
PHAP5-50VA2Q	8.50 (0.334)
PHAP5-30VA2K	7.30* (0.287)

\*=3.80 (0.149) SQ for caps

## 50V: 12 X 12 MM - VERTICAL - SURFACE MOUNT

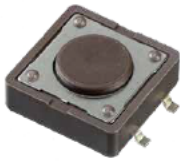

	Height H
PHAP5-50VA2A	4.30 (0.169)
PHAP5-50VA2Q	8.50 (0.334)
PHAP5-30VA2K	7.30* (0.287)

\*=3.80 (0.149) SQ for caps

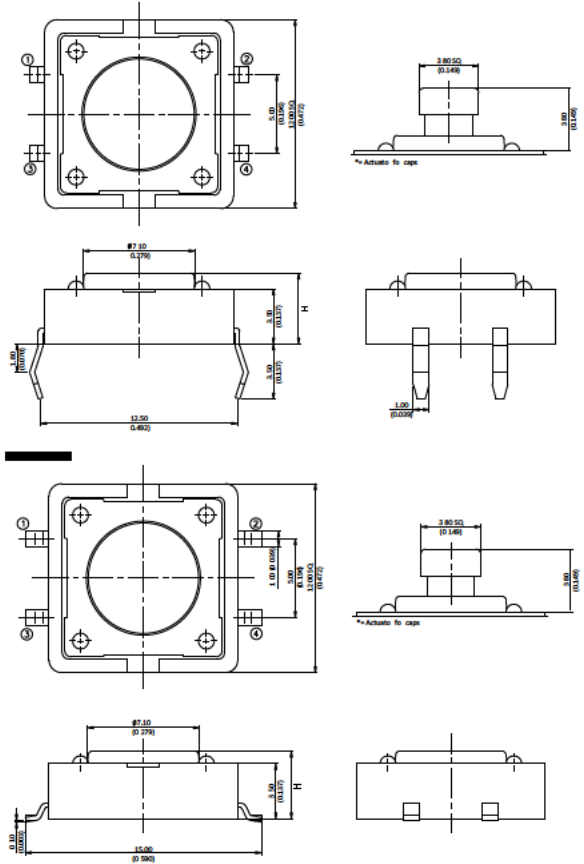

# PHAP5-50 series

Tact switches • 12 x 12 mm standard package

CAPS

BASIC P/N

+



U5540 12 mm square cap

U5550 13 mm round cap

Replace "0" by number for cap colors :

- 1 Blue
- 2 Black
- 3 Green
- 4 Grey
- 5 Yellow
- 6 Red
- 7 Ivory



## 12 MM SQUARE CAP

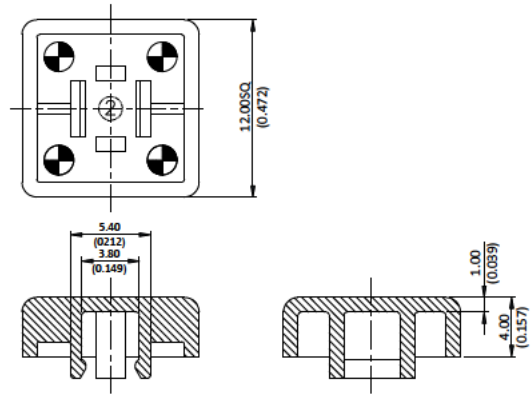

## 13 MM ROUND CAP

