

Specifications

Rating:	6A 250VAC, 10A 125VAC
Contact Resistance:	50mΩ Max
Insulation Resistance:	100MΩ Min
Dielectric Strength:	1500VAC 1 minute
Operating Temperature:	-25°C to +85°C
Electrical Life:	10,000+ Cycles

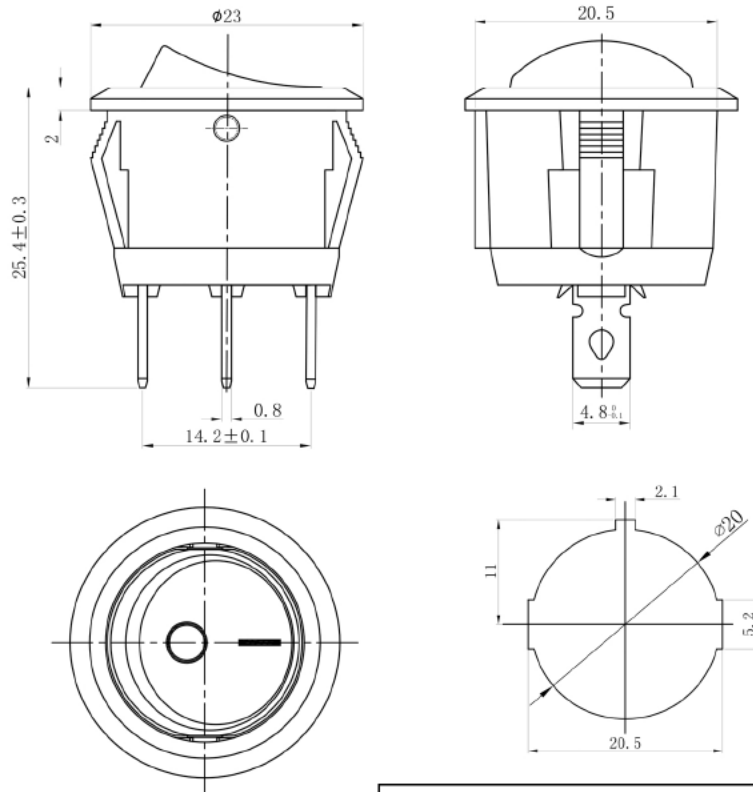

Description	Ref Code
Red illuminated On-Off Round Rocker Switch 12V SPST	130008