

S series

Washable rocker and paddle switches



DISTINCTIVE FEATURES

- Process sealed
- Front and rear sealing
- Process compatible
- Wave solderable
- Washable



ENVIRONMENTAL SPECIFICATIONS

- Operating temperature : -20 °C to +85 °C (-4 °F to +185 °F)
- Storage temperature : -40 °C to +85 °C (-40 °F to +185 °F)
- Moisture : The insulating materials employed and the complete seal permit the switches to withstand a 56 days moisture test (IEC 68-2-3).
- Solderability : The switches are tested at 235 °C (455 °F) according to IEC 68-2-20 after accelerated aging.



ELECTRICAL SPECIFICATIONS

- Max. current/voltage rating with resistive load :
 - silver contacts (A) : 4 A 30 VDC
 - brass, gold plated contacts (CD) : 0.4 VA 20 VAC or DC
 - silver, gold plated contacts (AD) : 4 A 30 VDC (300 mA 30 VDC for gold plating)
- Initial contact resistance : 10 mΩ max.
- Insulation resistance : 1,000 MΩ min.
- Dielectric strength : 1,000 Vrms 50 Hz min.
- Electrical life with nominal load :

Contacts	Number of cycles	
	2 positions	3 positions
A	40,000	40,000
CD	100,000	50,000
AD	40,000	40,000

The company reserves the right to change specifications without notice.

S series

Washable rocker and paddle switches



GENERAL SPECIFICATIONS

- Mechanical strength : Terminals are strengthened by a bracket or a ground plate ensuring the rigidity of the switch on the board. Actuator strength 10 N max.
- Soldering - thermal shock : The switches are especially designed for flow soldering at 260 °C (500 °F) during 5 seconds owing to high temperature polymer parts.



MATERIALS

- Case and cover : UL94-V0, polyamide, glass filled or PES
- Actuator : polyamide
- Contacts
 - CD : brass, gold plated
 - A : silver
 - AD : silver, gold plated
- Terminal seal : epoxy



ELECTRICAL FUNCTIONS



TERMINALS

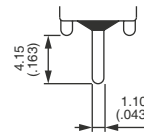

Straight PC

AGENCY APPROVAL



2 A 250 VAC
4 A 125 VAC

Availability : consult factory for details of approved models.

Marking : to order switches marked UL, complete appropriate box of ordering format.



PANEL CUT-OUT

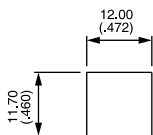

With rocker **U730** or paddle **U700**

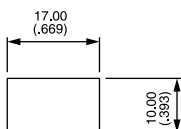

With rocker **U620** or paddle **U610**

S series

Washable rocker and paddle switches



BUILD YOUR PART NUMBER

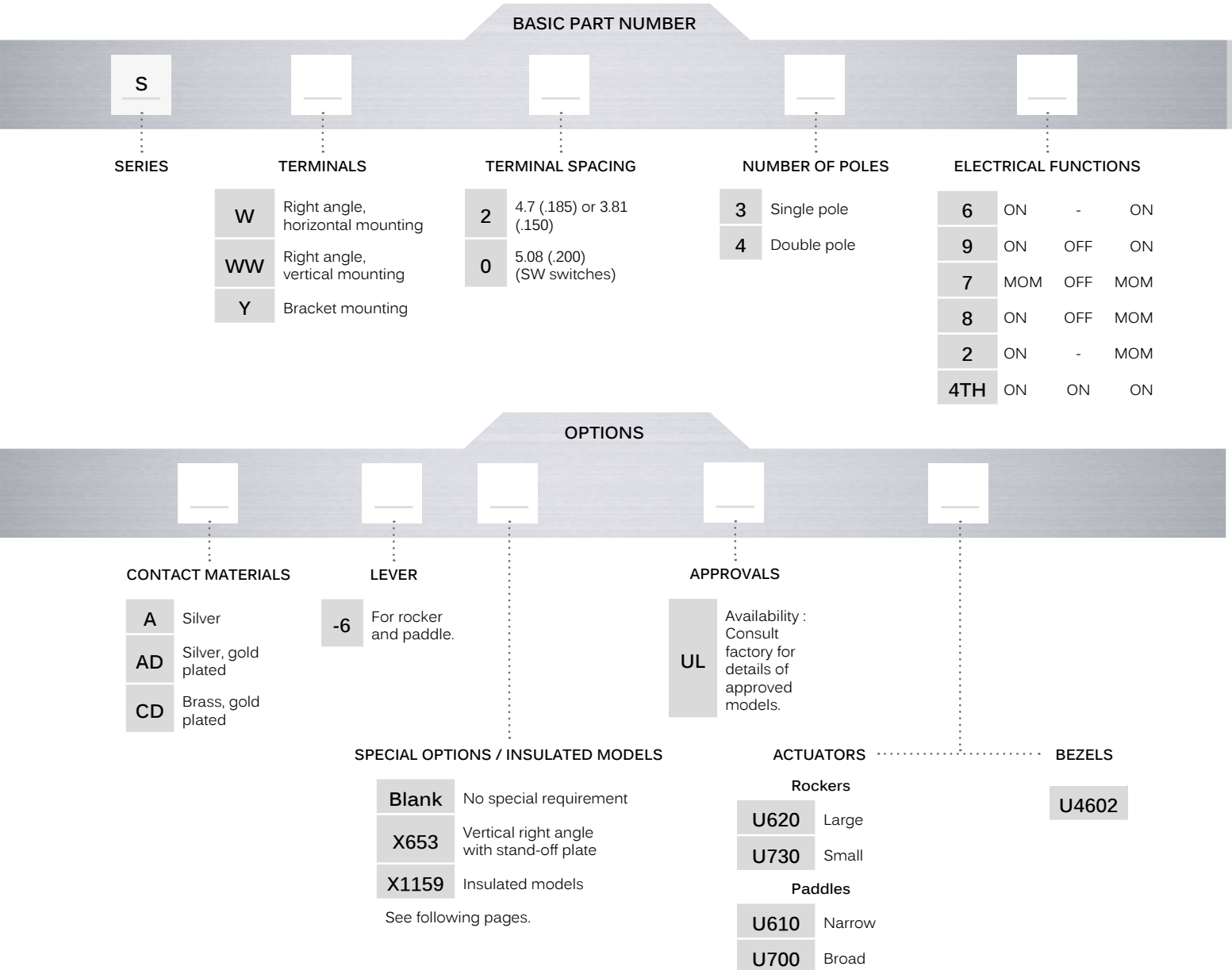

ABOUT THIS SERIES

On the following pages, you will find successively basic part numbers of switches and options in the same order as in above chart.



Notice : please note that not all combinations of above numbers are available. Refer to the following pages for further information.

S series

Washable rocker and paddle switches

RIGHT ANGLE TERMINALS - HORIZONTAL SPACING 4.7 (.185)



	Single pole	Double pole	III	II	I
	SW236-6	SW246-6	ON	-	ON
	SW239-6	SW249-6	ON	OFF	ON
	SW237-6	SW247-6	MOM	OFF	MOM
	SW238-6	SW248-6	ON	OFF	MOM
	SW232-6	SW242-6	ON	-	MOM
		SW244TH-6*	ON	ON	ON

*Function 4 : SP in DP case - TH connection, see "Technical information" on website. Single pole with stand-off plate, double pole without.

RIGHT ANGLE TERMINALS - VERTICAL



	Single pole	Double pole	III	II	I
	SWW236-6	SWW246-6	ON	-	ON
	SWW239-6	SWW249-6	ON	OFF	ON
	SWW237-6	SWW247-6	MOM	OFF	MOM
	SWW238-6	SWW248-6	ON	OFF	MOM
	SWW232-6	SWW242-6	ON	-	MOM
		SWW244TH-6*	ON	ON	ON

*Functions 2 and 8 : reversed connection available. Consult factory.

BRACKET MOUNTING



	Single pole	Double pole	III	II	I
	SY236-6	SY246-6	ON	-	ON
	SY239-6	SY249-6	ON	OFF	ON
	SY237-6	SY247-6	MOM	OFF	MOM
	SY238-6	SY248-6	ON	OFF	MOM
	SY232-6	SY242-6	ON	-	MOM
		SY244TH-6*	ON	ON	ON

*Function 4 : SP in DP case - TH connection, see "Technical information" on website.

Shown with rocker U620

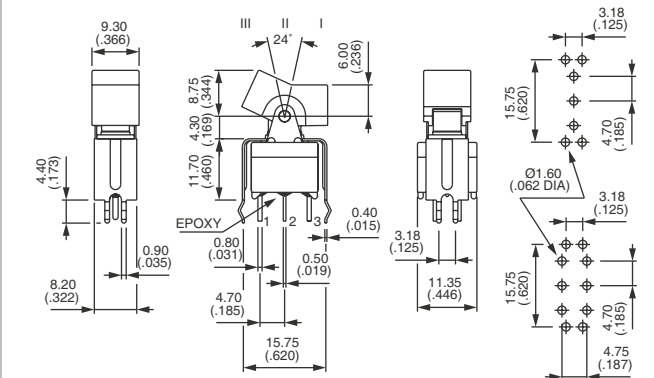
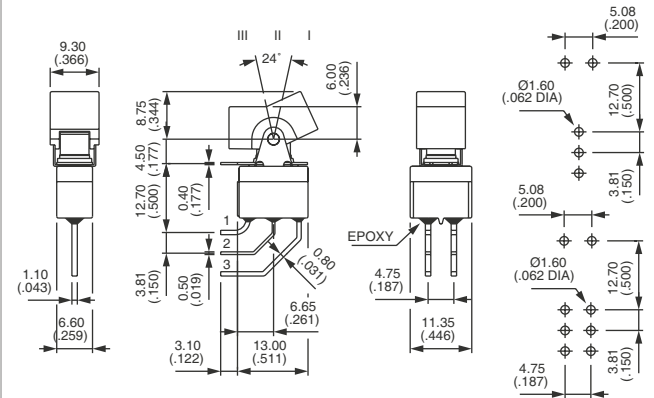
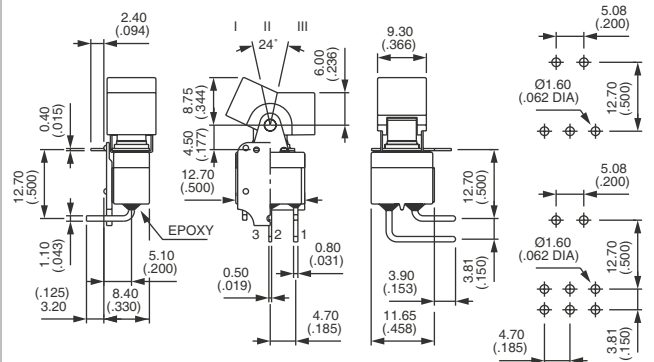

S series

Washable rocker and paddle switches

CONTACT MATERIALS

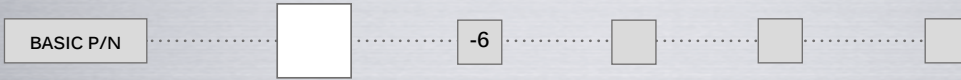

- A Silver
- AD Silver, gold plated
- CD Brass, gold plated

SPECIAL OPTIONS / INSULATED MODELS

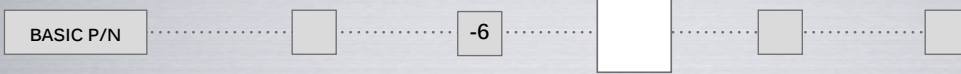

- X601** Silver plated brass contacts
Current/voltage rating for an electrical life of 20,000 cycles : 0.5 A 30 VDC
Minimum quantity : 5,000 per type and shipment.
- X653** Vertical right angle **with stand-off plate**
- X1159** **Insulated model** protected against E.S.D. up to 12 KV - **Vertical right angle**
Available with all actuators shown on next page.

OPTION X653



	III	II	I
Single pole			
SWW236-6 X653	ON	-	ON
SWW239-6 X653	ON	OFF	ON
SWW237-6 X653	MOM	OFF	MOM
SWW238-6 X653	ON	OFF	MOM
SWW232-6 X653	ON	-	MOM
Double pole			
SWW246-6 X653	ON	-	ON
SWW249-6 X653	ON	OFF	ON
SWW247-6 X653	MOM	OFF	MOM
SWW248-6 X653**	ON	OFF	MOM
SWW242-6 X653**	ON	-	MOM
SWW244TH-6 X653*	ON	ON	ON

Shown with rocker U620

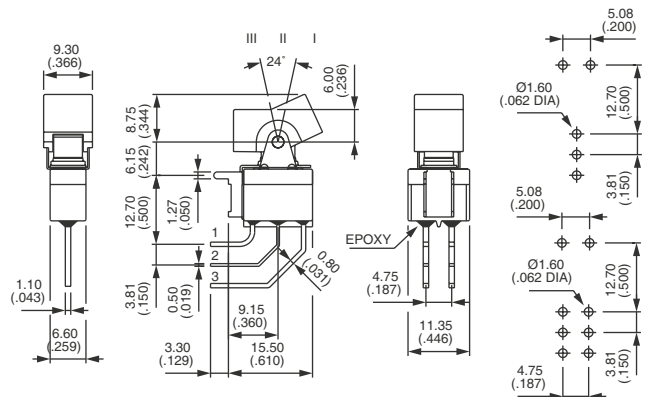

OPTION X1159



	III	II	I
Single pole			
SWW236-6 X1159	ON	-	ON
SWW239-6 X1159	ON	OFF	ON
SWW237-6 X1159	MOM	OFF	MOM
SWW238-6 X1159	ON	OFF	MOM
SWW232-6 X1159	ON	-	MOM
Double pole			
SWW246-6 X1159	ON	-	ON
SWW249-6 X1159	ON	OFF	ON
SWW247-6 X1159	MOM	OFF	MOM
SWW248-6 X1159**	ON	OFF	MOM
SWW242-6 X1159**	ON	-	MOM
SWW244TH-6 X1159*	ON	ON	ON

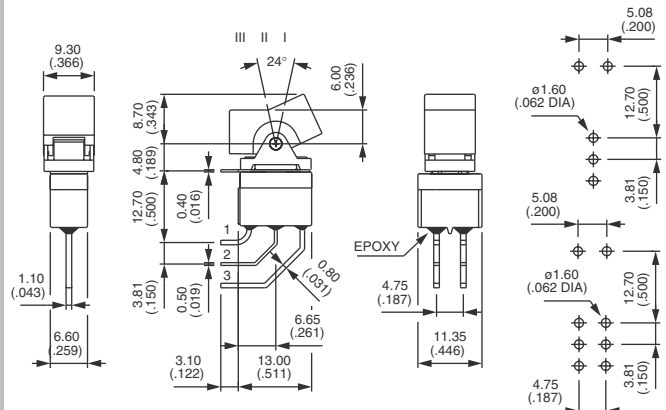

* Function 4 : SP in DP case - TH connection, see "Technical information" on website.
** Functions 2 and 8 : reversed connection available. Consult factory.

S series

Washable rocker and paddle switches

AGENCY APPROVAL



UL

Blank No agency approval required

Availability : consult factory for details of approved models.

Marking : to order switches marked with the UL symbol, complete above box with "UL".

ACTUATORS

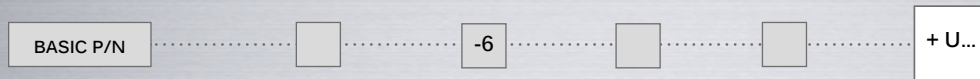

ROCKERS AND PADDLES

- U620** Large rocker
- U730** Small rocker
- U610** Narrow paddle
- U700** Broad paddle

For cap colors, replace "0" with number :

- 1** Blue
- 1/4** Dark blue
- 2** Black
- 3** Green
- 4** Grey
- 5** Yellow
- 6** Red
- 7/1** White
- 9** Orange

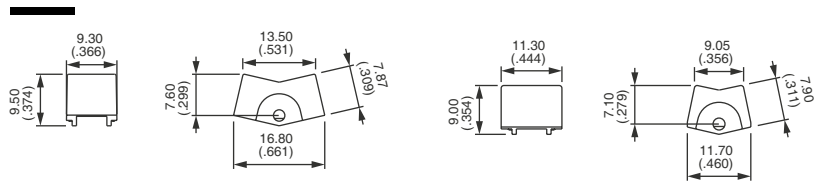

U620

U730

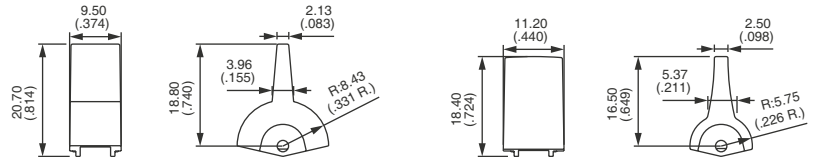

U610

U700

BEZEL

U4602 Black bezel - for rocker U620 only

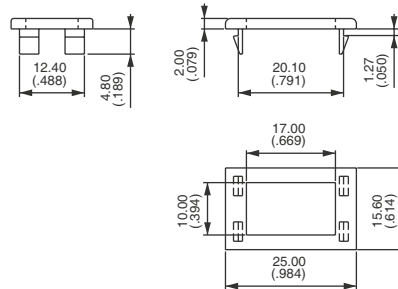

U4602

SR series

Washable rocker and paddle switches



DISTINCTIVE FEATURES

- Process sealed
- Front and rear sealing
- Large rocker



ENVIRONMENTAL SPECIFICATIONS

- Operating temperature : -20 °C to +85 °C (-4 °F to +185 °F)
- Storage temperature : -40 °C to +85 °C (-40 °F to +185 °F)
- Moisture : The insulating materials employed and the complete seal permit the switches to withstand a 56 days moisture test (IEC 68-2-3).
- Iron soldering : 300 °C (572 °F) 5 sec. max.
- Solderability : The switches are tested at 235 °C (455 °F) according to IEC 68-2-20 after accelerated aging.



ELECTRICAL SPECIFICATIONS

- Max. current/voltage rating with resistive load :
 - silver contacts (A) : 4 A 30 VDC
 - brass, gold plated contacts (CD) : 0.4 VA 20 VAC or DC
 - silver, gold plated contacts (AD) : 4 A 30 VDC (300 mA 30 VDC for gold plating)
- Initial contact resistance : 10 mΩ max.
- Insulation resistance : 1,000 MΩ min.
- Dielectric strength : 1,000 Vrms 50 Hz min.
- Electrical life with nominal load :

Contacts	Number of cycles	
	2 positions	3 positions
A	40,000	40,000
CD	100,000	50,000
AD	40,000	40,000



GENERAL SPECIFICATIONS

- Mechanical strength : Terminals are strengthened by a ground plate ensuring the rigidity of the switch on the board. Actuator strength is 10 N max.

The company reserves the right to change specifications without notice.



SR series

Washable rocker and paddle switches



MATERIALS

- Case and cover : UL94-V0, polyamide, glass filled or PES
- Actuator : polyamide
- Contacts
 - 0 : brass, gold plated
 - 1 : silver
 - 2 : silver, gold plated
 - 5 : special, lower rating
- Terminal seal : epoxy



PANEL CUT-OUT

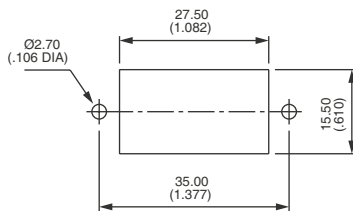

ELECTRICAL FUNCTIONS

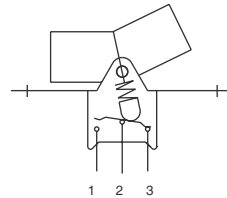

TERMINALS

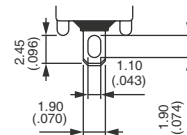

Solder lug

SR series

Washable rocker and paddle switches



BUILD YOUR PART NUMBER

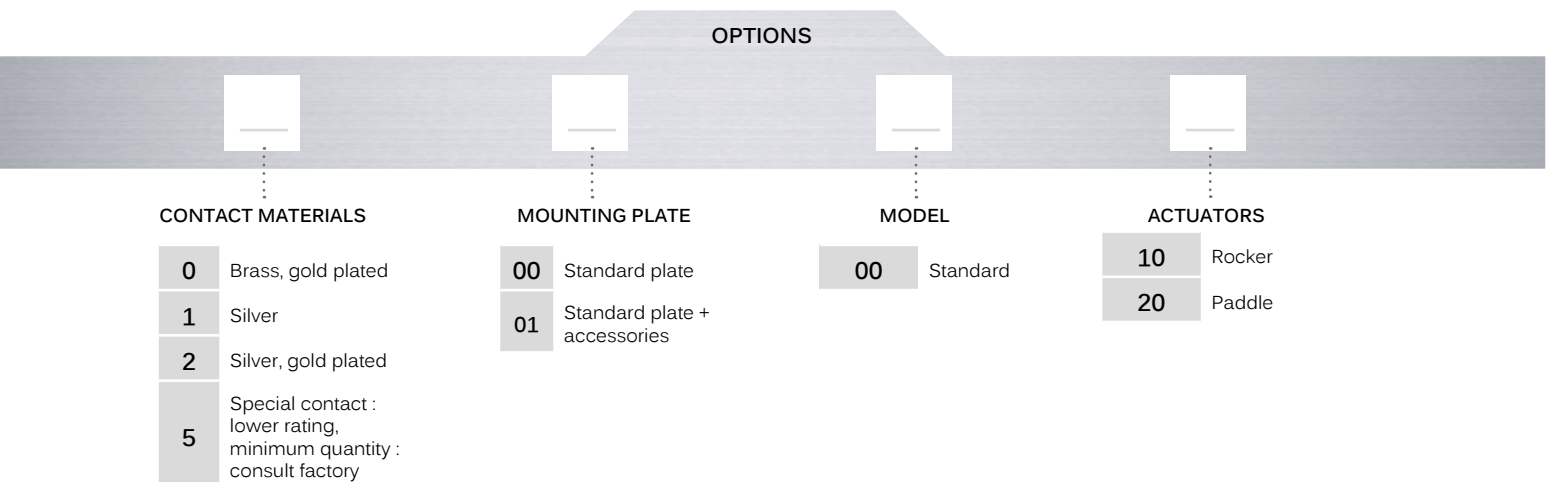
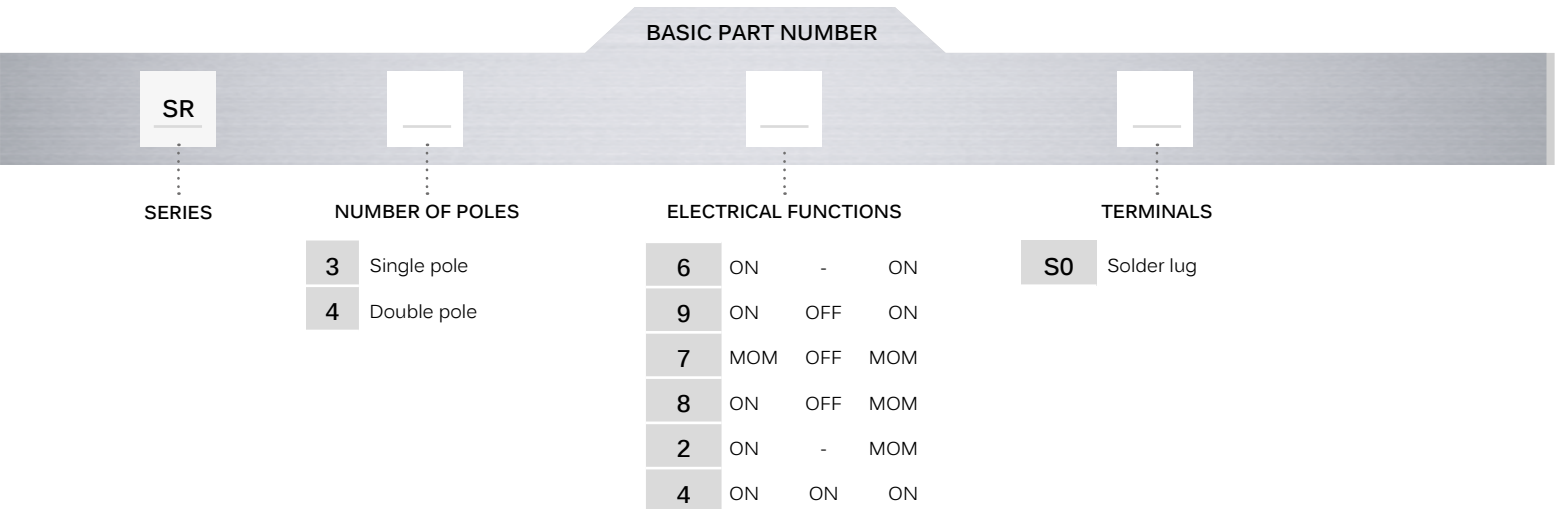

ABOUT THIS SERIES

On the following pages, you will find successively basic part numbers of switches and options in the same order as in above chart.



Notice : please note that not all combinations of above numbers are available. Refer to the following pages for further information.

SR series

Washable rocker and paddle switches

SOLDER LUG TERMINALS



		III	II	I
Single pole	Double pole			
SR36S0	SR46S0	ON	-	ON
SR39S0	SR49S0	ON	OFF	ON
SR37S0	SR47S0	MOM	OFF	MOM
SR38S0	SR48S0	ON	OFF	MOM
SR32S0	SR42S0	ON	-	MOM
	SR44S0*	ON	ON	ON

* Function 4 : SP in DP case - TH connection, see "Technical information" on webs te.

Shown with standard mounting plate (code 00)

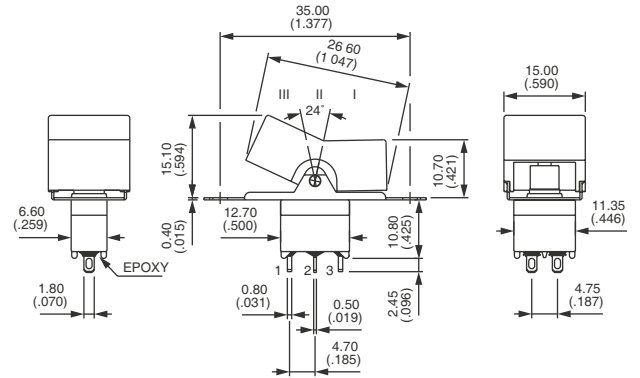

CONTACT MATERIALS



- 0 Brass, gold plated
- 1 Silver
- 2 Silver, gold plated
- 5 Special contact, lower rating, minimum quantity : consult factory.

MOUNTING PLATE



- 00 Standard mounting plate
- 01 Standard mounting plate + mounting accessories (spacers, screws and nuts)

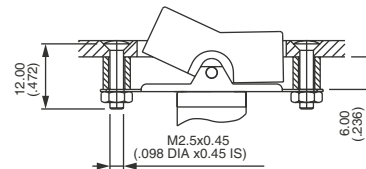

ACTUATORS



- 10 Rocker
- 20 Paddle

For cap colors, replace "0" with number :

- 1 Blue
- 1/4 Dark blue
- 2 Black
- 3 Green
- 4 Grey
- 5 Yellow
- 6 Red
- 7/1 White
- 9 Orange

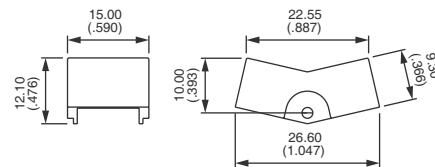

10

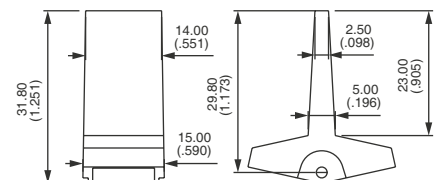

20