

9400-9600 series

Momentary pushbutton switches



DISTINCTIVE FEATURES

Two case lengths

Three electrical functions

Sealing options

Model X1146 with Ø 16 (.630) bushing



ELECTRICAL SPECIFICATIONS

- Max. current/voltage rating with resistive load :
 - silver contact (A) : 1 A 30 VDC
 - gold plated contacts (CD) : 100 mA 30 VDC
- Initial contact resistance : 50 mΩ max.
- Insulation resistance : 1,000 MΩ min. at 500 VDC
- Dielectric strength :
 - 1,000 Vrms 50 Hz min. between terminals
 - 1,500 Vrms 50 Hz min. between terminals and frame
- Electrical life : 250,000 cycles



GENERAL SPECIFICATIONS

- Total travel :

9600-9400-9400Y		9600N-9400N
Functions 3 and 5	Function 2	Function 3
1.3 mm	2 mm	0.9 mm

- Torque : 1.25 Nm (.922 Ft.lb) max. applied to nut
- Operating temperature : -30 °C to +65 °C (-22 °F to +149 °F)



MATERIALS

- Case : thermoplastic UL94-V0
- Actuator : polyamide, glass filled
- Bushing : brass, nickel plated
- Contacts :
 - A : silver
 - CD : brass, gold plated
- Terminal seal : epoxy



9400-9600 series

Momentary pushbutton switches



PANEL CUT-OUT

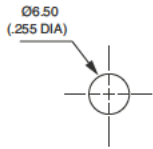

TERMINALS

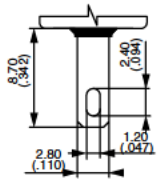

9600Z1

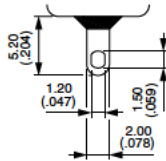

9600

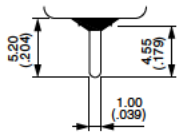

9400



ELECTRICAL FUNCTIONS



Function 2 (NC)

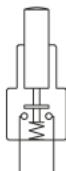

Function 3 (NO)



Function 5 (combined)

9400-9600 series

Momentary pushbutton switches



BUILD YOUR PART NUMBER

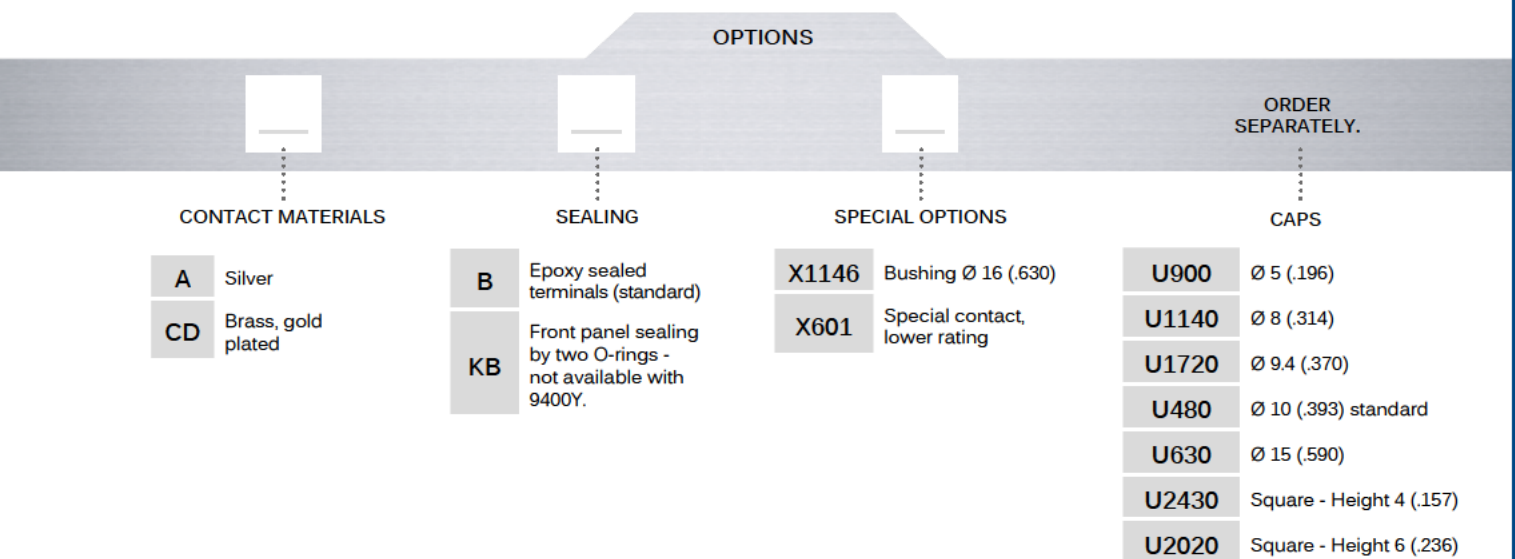
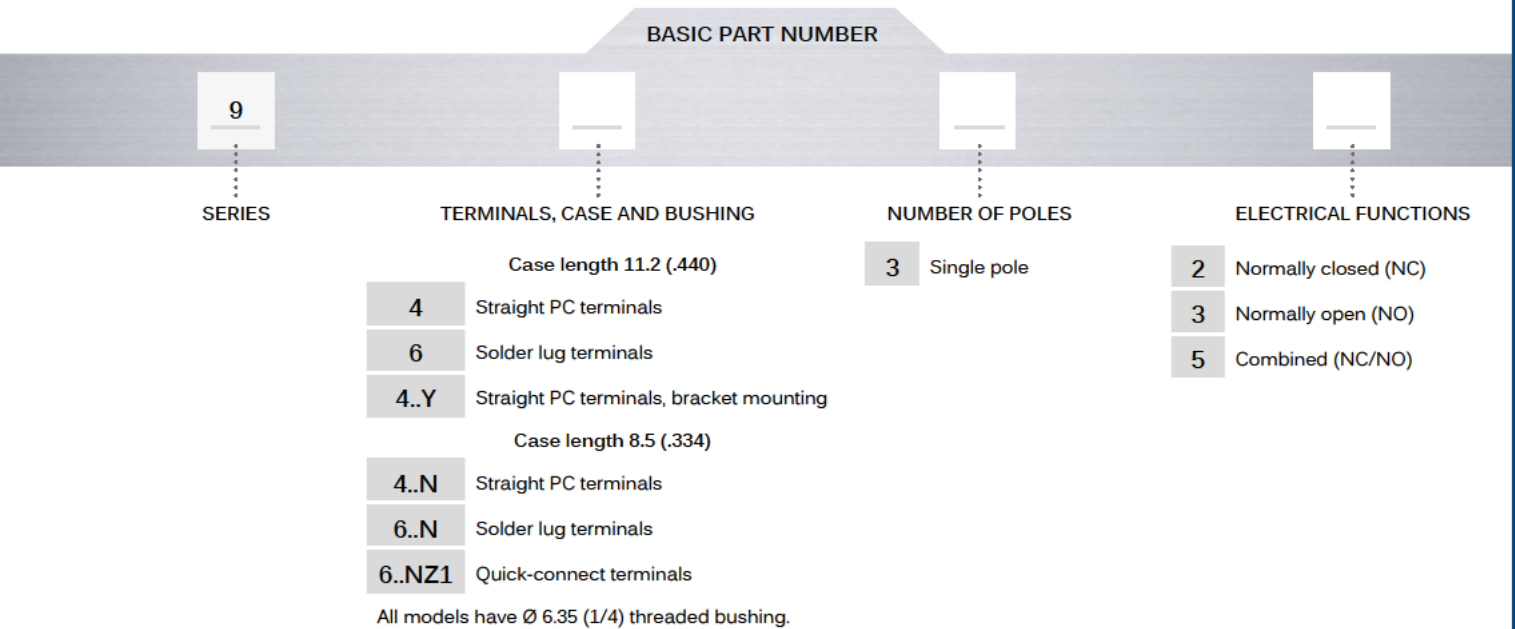

ABOUT THIS SERIES

On the following pages, you will find successively basic part numbers of switches and options in the same order as in above chart.

- ⚠ **Notice** : please note that not all combinations of above numbers are available. Refer to the following pages for further information.
- 🛡 **Sealing boots** are available to protect the switches against dust and water. See "Sealing Boots" section of website.
- 🔧 **Mounting accessories** : standard hardware supplied with all models : 2 hex nuts 8 mm (.314) across flats and 1 lockwasher. Standard and special hardware available is presented in the "Hardware" section of website.

9400-9600 series

Momentary pushbutton switches

SOLDER LUG TERMINALS CASE LENGTH 11.2 (.440) : 9600



9632 B  Normally Closed

9635 B  Combined function

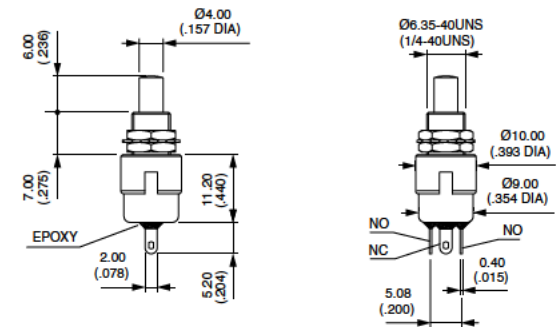

STRAIGHT PC TERMINALS CASE LENGTH 11.2 (.440) : 9400



9432 B  Normally Closed

9433 B  Normally Open

9435 B  Combined function

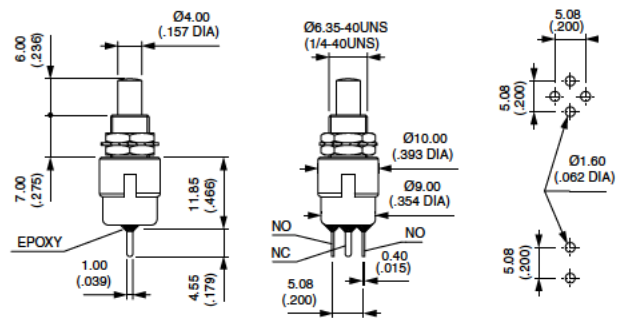

BRACKET MOUNTING CASE LENGTH 11.2 (.440) : 9400Y



9432Y B  Normally Closed

9433Y B  Normally Open

9435Y B  Combined function

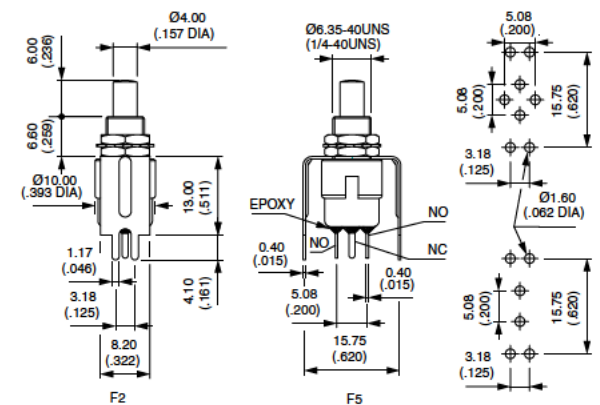

The bracket is not fastened to the switch.

SOLDER LUG TERMINALS CASE LENGTH 8.5 (.334) : 9600N



9633N B  Normally Open

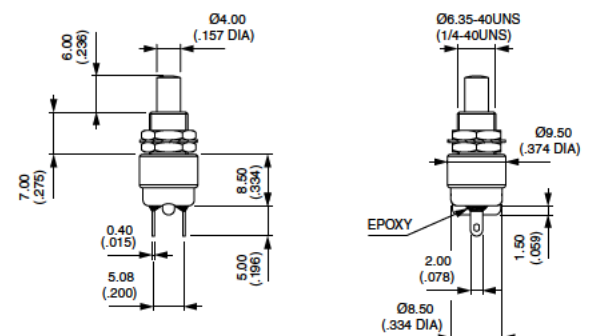

Also available with quick-connect terminals 2.8 x 0.5 mm : 9633NZ1

9400-9600 series

Momentary pushbutton switches

STRAIGHT PC TERMINALS CASE LENGTH 8.5 (.334) : 9400N



9433N B  Normally Open

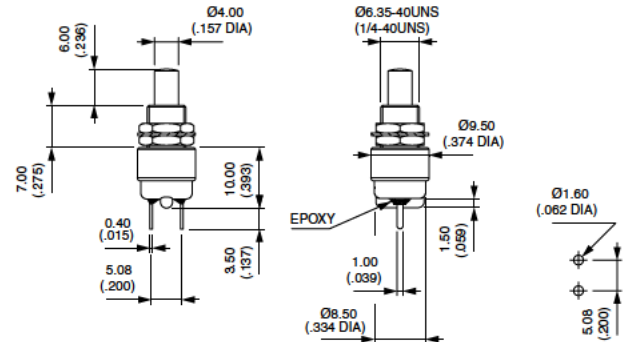

BUSHING Ø 16 (.630) METAL PLUNGER : 9633•X1146



Silver contact
9633ABX1146  Normally Open

Gold plated silver contacts
9633ADBX1146  Normally Open

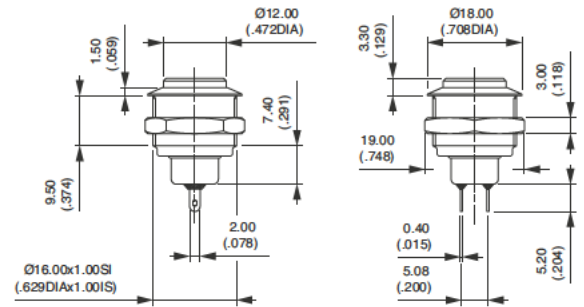

Hex nut 19 (.748) across flats

Panel cut-out : Ø 16.2 (.637)
Max. current/voltage rating. : 1 A 30 VDC
Epoxy sealed terminals. Options of the following pages not applicable.

CONTACTS MATERIALS



- A Silver
- CD Brass, gold plated

Special contact, lower rating : see X601 under "Special options".

SEALING



- B Epoxy sealed terminals (standard)
- KB Combined sealings
Epoxy sealed terminals + front panel sealing by two O-rings. Protects the switch against water and dust. Panel seal withstands 0.1 bar pressure. Option KB not available on 9400Y model.

Sealing boots : see "Sealing boots" section of website.

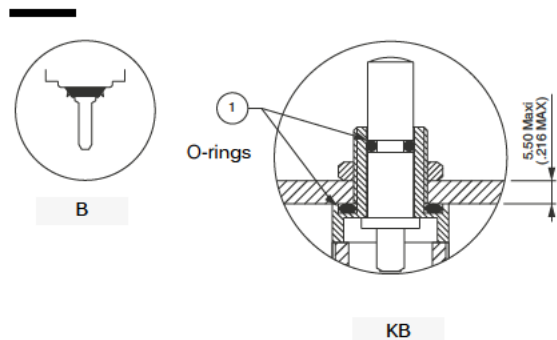

9400-9600 series

Momentary pushbutton switches

SPECIAL OPTIONS

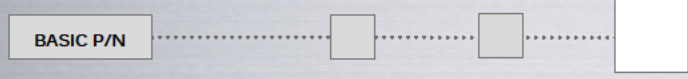

X601 Silver plated brass contacts
 Current/voltage rating for an electrical life of 20,000 cycles : 0.5 A 30 VDC.
 Minimum quantity : 5,000 pieces per model and shipment.

X1146 Model with dia. 16 (.630) bushing and metal plunger
 See previous page.

CAPS

Order separately.

For cap colors, replace last "0" by number :

- 1 Blue
- 1/4 Dark blue
- 2 Black
- 3 Green
- 4 Grey
- 5 Yellow
- 6 Red
- 7 Ivory
- 7/1 White
- 9 Orange

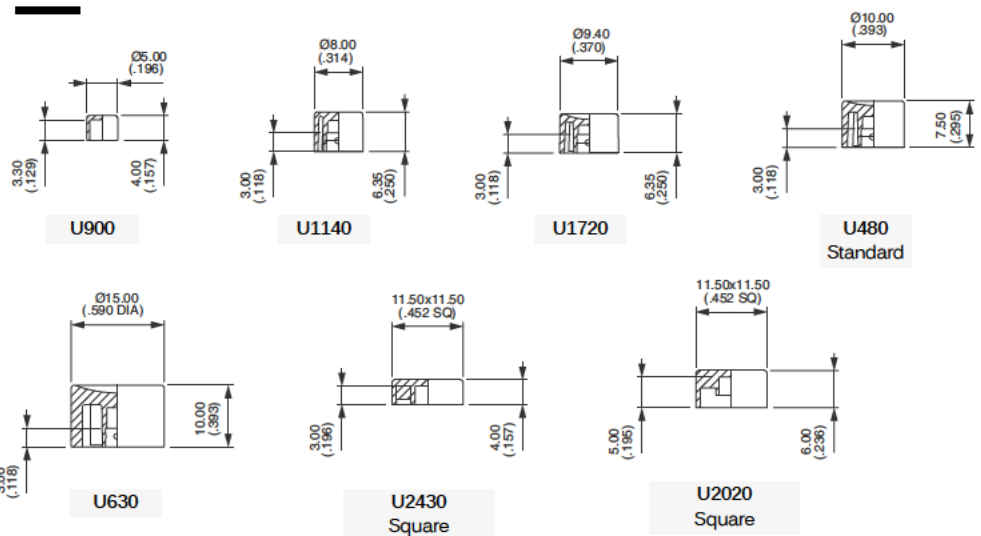

DRESS NUTS

Order separately. Chrome plated.

