

# V series

Stainless steel keypads for harsh environments



## DISTINCTIVE FEATURES

- Round or square keys
- Rear mounting
- 316L stainless steel : frame and keytops
- Panel sealed to IP65
- Custom markings on request



## ENVIRONMENTAL SPECIFICATIONS

- Front sealing : IP65 according to NFC 21-010, IEC 60529 and DIN 40050
- Operating temperature : -20 °C to +70 °C (-4 °F to +158 °F)
- Storage temperature : -40 °C to +85 °C (-40 °F to +185 °F)
- Impact resistance : IK09 according to EN 50102
- Flame resistance : UL94 HB horizontal position (30 seconds max).
- Salt spray : 96 hours according to IEC 512-6, test 11f
- Washable : most commonly used detergents and solvents



## ELECTRICAL SPECIFICATIONS

- Output type : matrix (NO contacts)
- Max. current/voltage rating with resistive load : 50 mA at 12 VDC
- Initial contact resistance ON : 10Ω max.
- Insulation resistance : 1GΩ min. at 500 VDC
- LED backlight : 12 VDC (standard)



## GENERAL SPECIFICATIONS

- Contact force : 4 N ± 0.5 N (non-illuminated version)  
3.5 N (illuminated version)
- Stroke : 0.5 mm (.019)
- Low level or mechanical life : 1 million cycles
- Panel thickness : 2.5 mm (.098) (standard version)
- Connection : male connector

The company reserves the right to change specifications without notice.

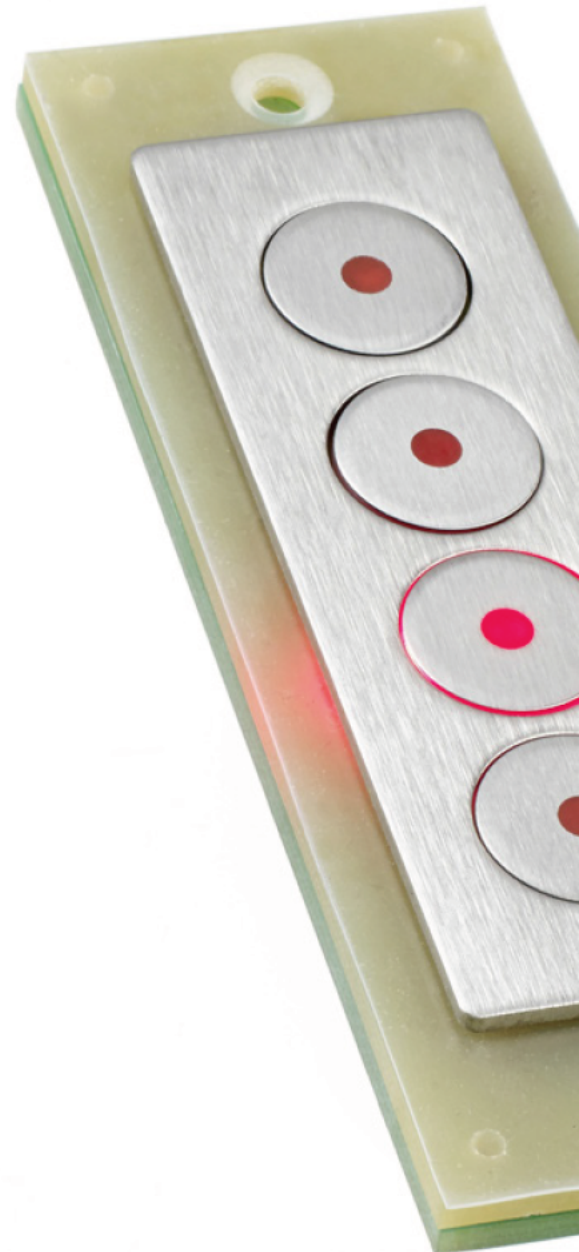
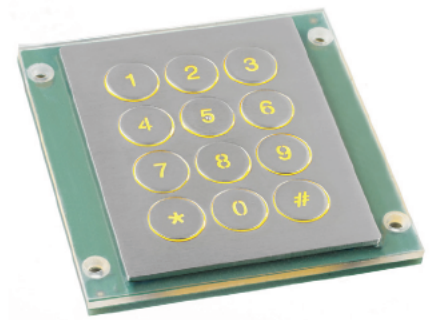

---

# V series

---

Stainless steel keypads for harsh environments



## MATERIALS

- Keytop : 316L stainless steel
- Keys : ABS or PA6 nylon (illuminated versions)
- Key holder : ABS or PA6
- Frame : 316L stainless steel
- PCB : FR4
- Seal : 0.4 mm thick silicone
- Actuator : stainless steel snap domes AISI 304
- Contacts : gold plated

Stainless steel keypads for harsh environments



## BUILD YOUR PART NUMBER

### BASIC PART NUMBER



#### MODELS

<b>VR0</b>	Ø 17 (.669) round keys
<b>V00</b>	Ø 20 (.787) round keys
<b>VH0</b>	Ø 20 (.787) round keys with plastic bezel
<b>VQR</b>	17 x 17 (.669x.669) square keys
<b>VQ0</b>	22 x 22 (.866x.866) square keys

VH0 not available with 12 or 16 keys  
VQR non-illuminated only



#### NO OF KEYS

<b>01</b>	1 key
<b>04</b>	4 keys
<b>12</b>	12 keys
<b>16</b>	16 keys



#### FRAME

<b>0</b>	No frame
<b>1</b>	With frame (4/12/16 keys models)



#### ILLUMINATION

<b>0</b>	Non-illuminated
<b>L</b>	Illuminated (not for VQR)

### OPTIONS



#### LED COLORS

<b>XX</b>	No LED
<b>0R</b>	Red
<b>0B</b>	Blue
<b>0G</b>	Green
<b>0Y</b>	Yellow
<b>0W</b>	White
<b>XR</b>	Green/blue/ yellow/red
<b>RB</b>	Red/blue
<b>RG</b>	Red/green



#### VOLTAGE

<b>XX</b>	Without
<b>05</b>	5 VDC
<b>12</b>	12 VDC
<b>24</b>	24 VDC



#### MARKING

<b>0</b>	Blank keys
<b>S</b>	Standard marking
<b>C</b>	Custom marking



## ABOUT THIS SERIES

Some configurations are shown on the following pages. Other drawings are available on request.

⚠ Notice : please note that not all combinations of above numbers are available. Refer to the following pages for further information.

# V series

Stainless steel keypads for harsh environments

Ø 17 MM (.669) ROUND KEY  
SINGLE KEY MODEL - NON-ILLUMINATED

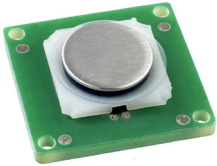

VR00100

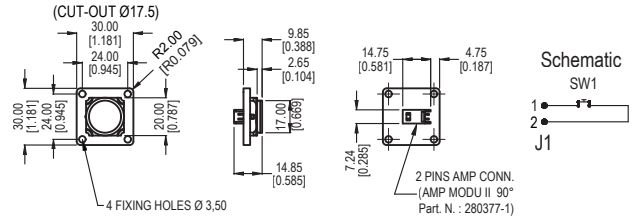

Ø 17 MM (.669) ROUND KEY  
SINGLE KEY MODEL - ILLUMINATED

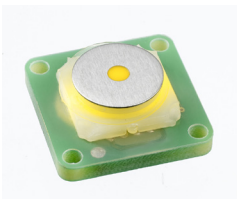

VR0010L

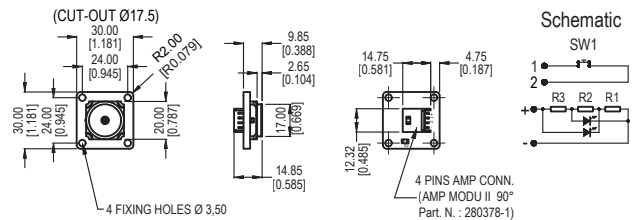

Ø 17 MM (.669) ROUND KEYS  
4-KEY MODEL - NON-ILLUMINATED



VR00410

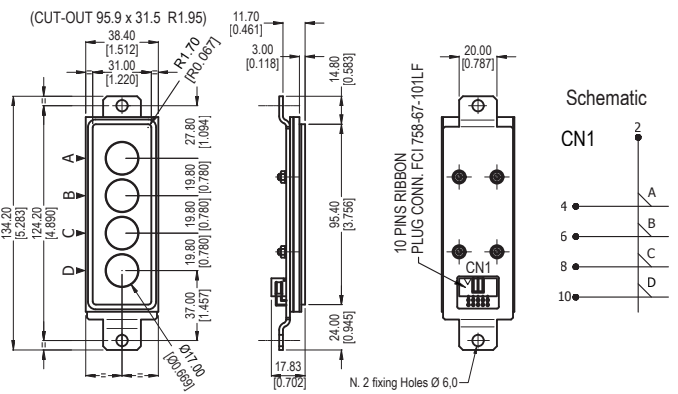

Ø 17 MM (.669) ROUND KEYS  
4-KEY MODEL - ILLUMINATED

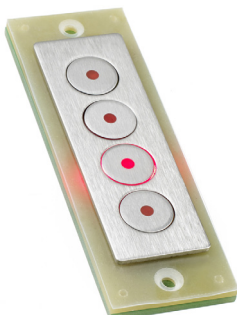

VR0041L

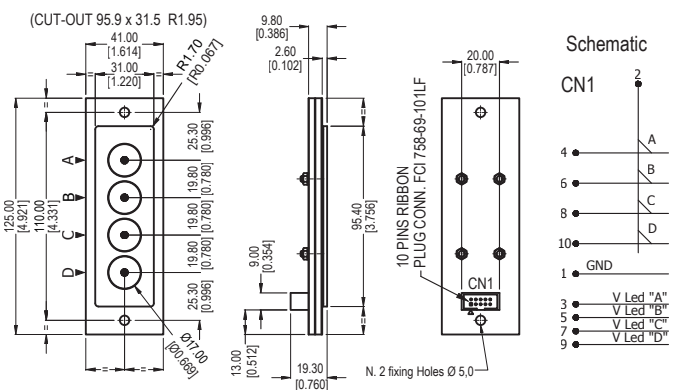





# V series

Stainless steel keypads for harsh environments

Ø 20 MM (.787) ROUND KEY  
SINGLE KEY MODEL - ILLUMINATED

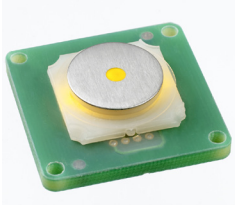

V00010L

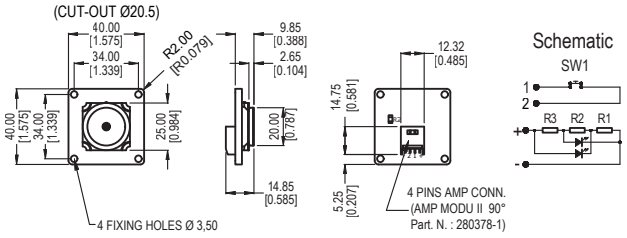

Ø 20 MM (.787) ROUND KEYS  
4-KEY MODEL - NON-ILLUMINATED



V000410

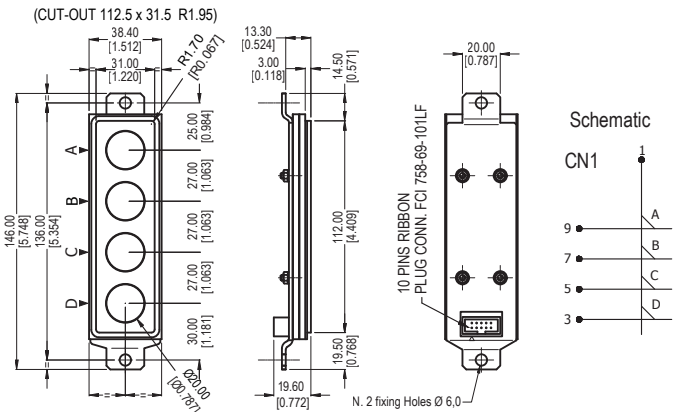

Ø 20 MM (.787) ROUND KEYS  
12-KEY MODEL - NON-ILLUMINATED



V001210

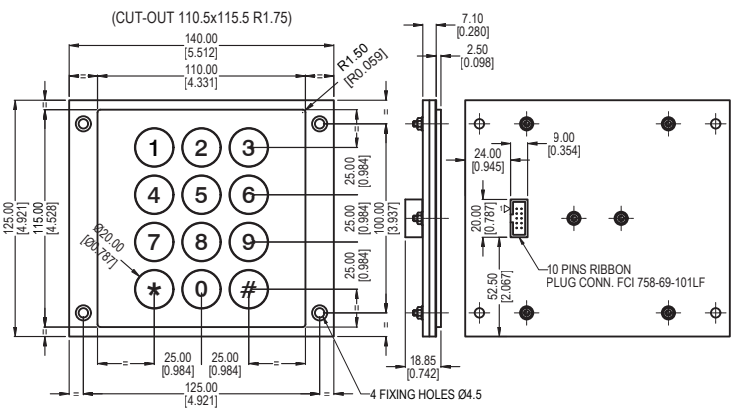

Ø 20 MM (.787) ROUND KEYS  
16-KEY MODEL - ILLUMINATED



V001610

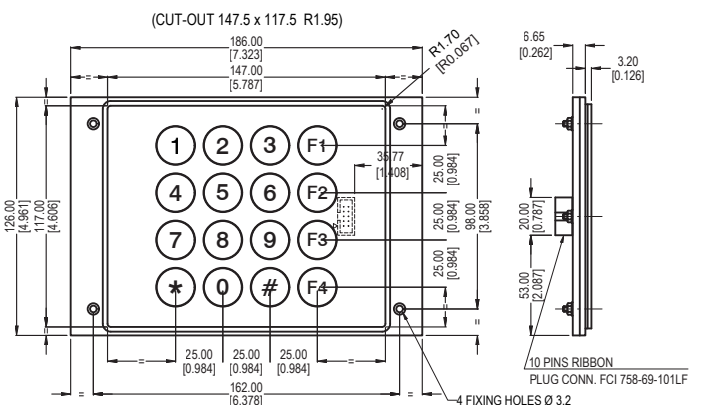

Stainless steel keypads for harsh environments

**Ø 20 MM (.787) ROUND KEY  
SINGLE KEY MODEL - NON-ILLUMINATED**

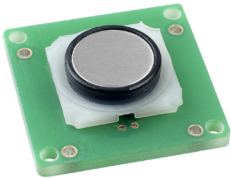

VH00100

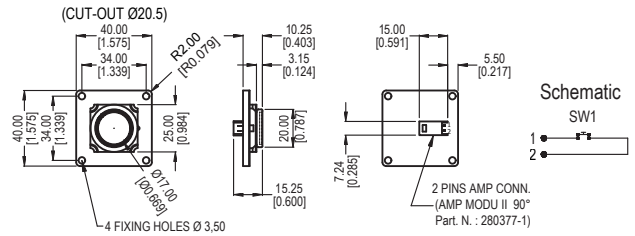

**Ø 20 MM (.787) ROUND KEY  
SINGLE KEY MODEL - ILLUMINATED**

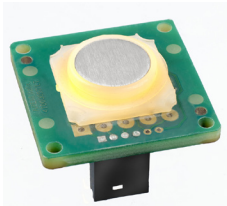

VH0010L

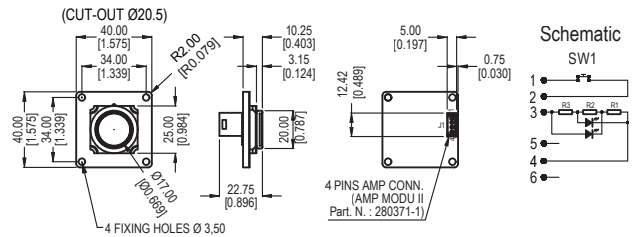

**17 MM (.669) SQUARE KEY  
SINGLE KEY MODEL - NON-ILLUMINATED**

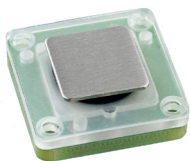

VQR0100

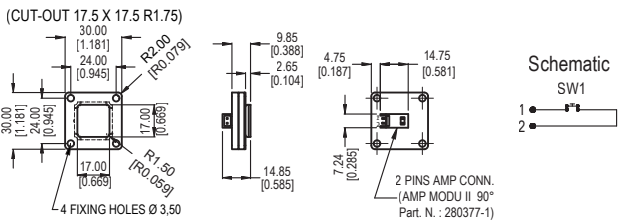

**17 MM (.669) SQUARE KEYS  
4-KEY MODEL - NON-ILLUMINATED**



VQR0410

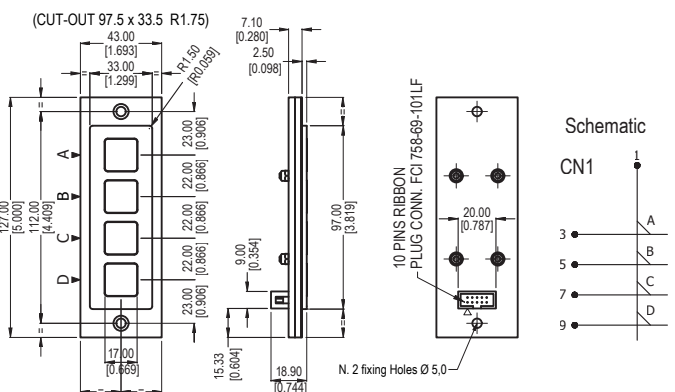

# V series

Stainless steel keypads for harsh environments

17 MM (.669 X .669) SQUARE KEYS  
12-KEY MODEL - NON-ILLUMINATED

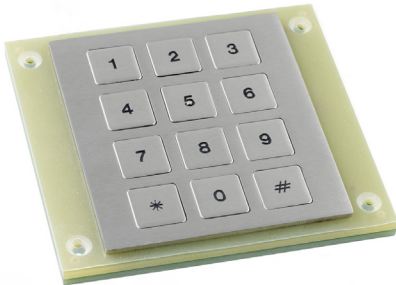

VQR1210

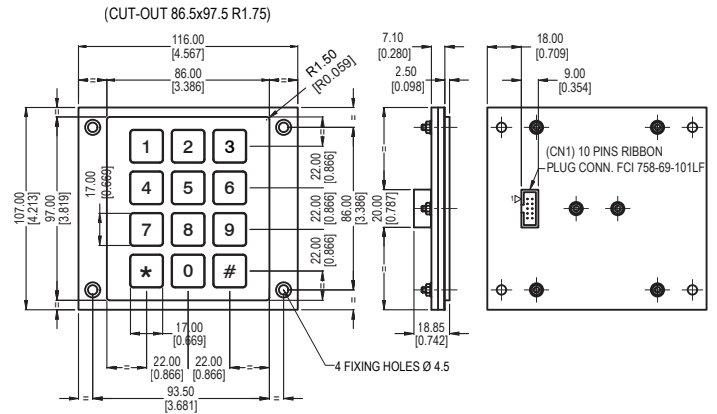

17 MM (.669) SQUARE KEYS  
16-KEY MODEL - NON-ILLUMINATED



VQR1610

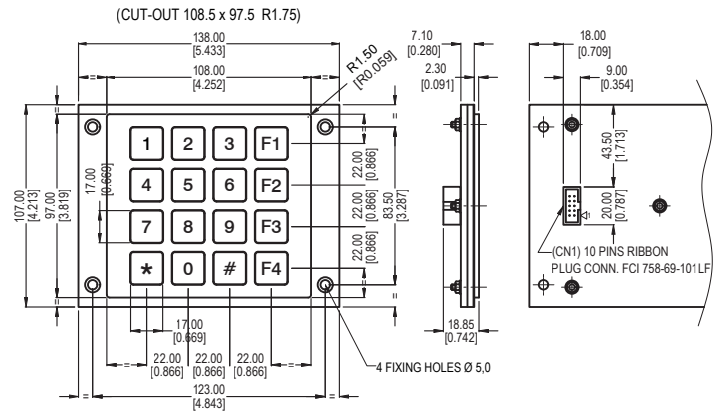

22 MM (.866) SQUARE KEY  
SINGLE KEY MODEL - NON-ILLUMINATED

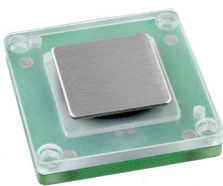

VQ00100

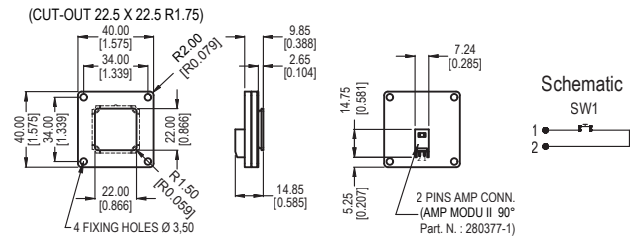

22 MM (.866) SQUARE KEY  
SINGLE KEY MODEL - ILLUMINATED

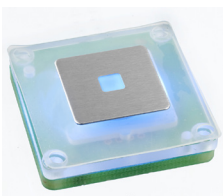

VQ0010L

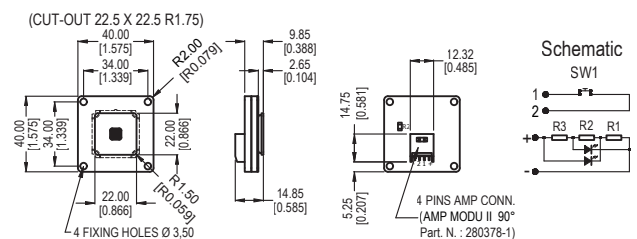



Stainless steel keypads for harsh environments

22 MM (.866) SQUARE KEYS  
4-KEY MODEL - NON-ILLUMINATED

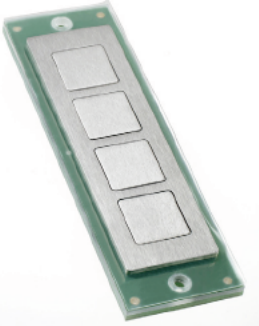

VQ00410

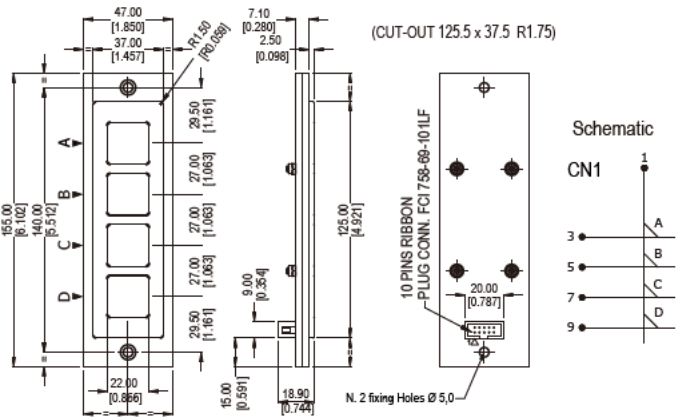

22 MM (.866) SQUARE KEYS  
12-KEY MODEL - NON-ILLUMINATED

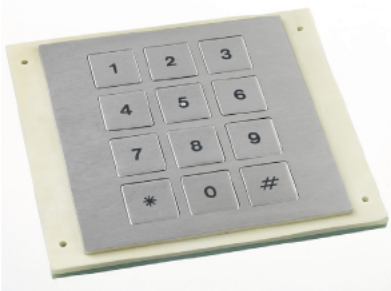

VQ01210

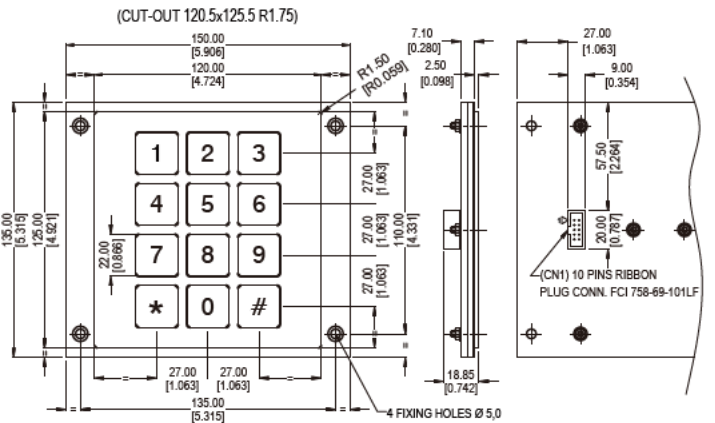

22 MM (.866) SQUARE KEYS  
16-KEY MODEL - NON-ILLUMINATED



VQ01610

