

Push Button Switches

Specifications

Rating:	3A 250VAC
Protection Level:	IP65
Housing Material:	Stainless Steel
Contacts:	1NO/1NC
Contact Resistance:	50mΩ Max
Insulation Resistance:	1000MΩ Min
Dielectric Strength:	2000VAC 1 minute
Operating Temperature:	-20°C to +55°C

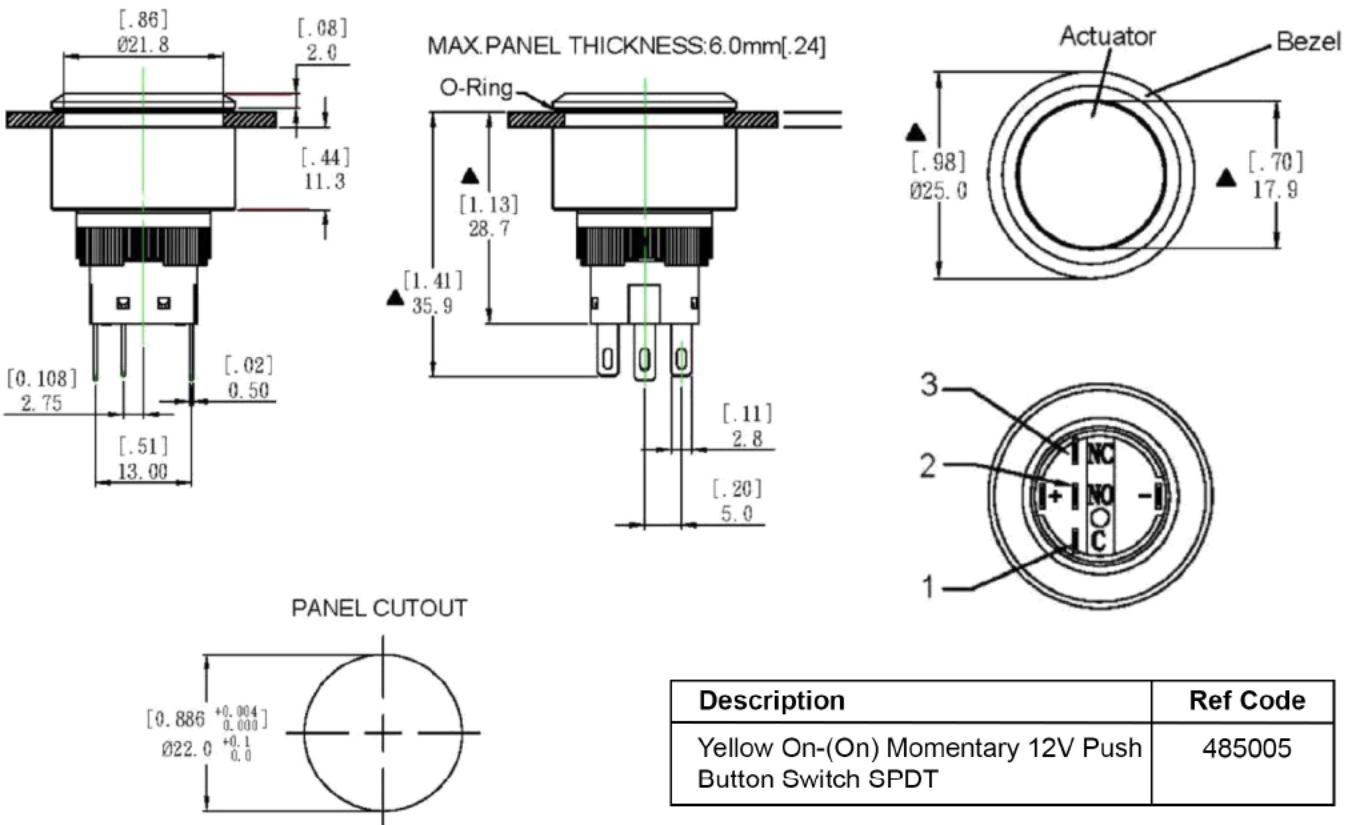

Description	Ref Code
Yellow On-(On) Momentary 12V Push Button Switch SPDT	485005